



PICKETT EQUIPMENT

Operator's Manual



Twin Master Dry Edible Bean Combine

Central Flow -- Low Impact



Pickett Equipment

976 East Main Street * Phone: 208-678-0855 * www.pickettequipment.com
Burley, Idaho 83318 * Fax: 208-678-1404 * pickett@rvmi.com

Twin Master Combine

Table of Contents

Table of Contents	I
Congratulations	1
Pickett Equipment Warranty	2
Disclaimers	3
Pre-delivery Checklist	4-7
Delivery Checklist.....	8
After Sale Checklist.....	9
Safety Information	10-13
Introduction.....	14
General Operating Instructions.....	15-17
Lights and Signals.....	18
Setting up the Tractor	19
Shaft Monitor System.....	20-22
AgCam System	22-23
Complete Drive Train	24
Feeder House.....	25-26
Concave Separator and Threshing Cylinder	27-28
Combine Cylinder Adjustment	29
Combine Cylinder Startup Settings	30
Combine Shaker-Separator	31
Final Sieve.....	32
Vacuum Cleaning System.....	33
Bucket Elevator	34
Unloading System	35
Straw Chopper	36
Shaft Monitoring System	37
Cleaning Out the Combine.....	38
Belt sizes and Configurations	39
Chain sizes and Configurations	40
Lubrication and Maintenance	41-43
Tire Specifications.....	44
Storage & Winterizing	44
Trouble Shooting.....	45-47
Average Fan and Chopper Speeds	48
Specifications	49



*Manufacturers of
the Most Innovative
Bean Equipment*

Congratulations on the purchase of your new Pickett Twin Master Edible Bean Combine. We welcome you to an ever-growing family of farmers using the Pickett system to harvest their bean crops, as well as peas and lentils. Thanks to your patronage, and the patronage of others like you, Pickett Equipment has become recognized as the most progressive and innovative bean harvesting equipment manufacturer in the industry.

We credit the customer with our success. After all, it is the farmer's input and suggestions over the years that has molded and refined the Pickett Equipment designs. We will continue to value the knowledge that you contribute, and seek to be responsive to your needs.

We encourage you to read the Operators Manual thoroughly and carefully to ensure satisfactory and trouble-free operation. Failure to do so could result in equipment failure or personal injury. Again, we thank you for choosing Pickett Equipment.

Sincerely,

PICKETT EQUIPMENT

Neil Harper, CPA
President/CEO

PICKETT FARM EQUIPMENT WARRANTY

Pickett Equipment warrants to the original purchaser of each item of new Pickett Farm Equipment that the product be free from defects in material and workmanship under normal use and service. If such equipment is found to be defective within one season or 350 acres, whichever shall occur first, the obligation of **PICKETT EQUIPMENT** under this warranty is limited to the repairing or replacing of (exclusive of the cost of labor and transportation), any equipment or parts, in the judgment of **PICKETT EQUIPMENT** to be defective in material or workmanship.

All equipment or parts claimed to be defective in material or workmanship must be made available for inspection at the place of business of a dealer authorized to handle the equipment covered by this warranty, or, upon request by **PICKETT EQUIPMENT**, shipped to the **PICKETT EQUIPMENT** factory in Burley, Idaho. **PICKETT EQUIPMENT shall have no obligation to bear the cost of labor or transportation in connection with replacement or repair of any such defective parts.** **PICKETT EQUIPMENT** will pay internal shop rates on the modification or repair of defective parts in the setup procedure.

This warranty covers only defects in material and workmanship. It does not cover depreciation or damage caused by normal wear, accident, improper assembly, improper adjustments, improper maintenance including lack of proper lubrication, or improper use. Therefore, **PICKETT EQUIPMENT** liability under this warranty shall not be effective or actionable unless the equipment is assembled, maintained and operated in accordance with the Operating instructions accompanying the equipment. **PICKETT EQUIPMENT** shall have no liability if the equipment has been altered or reworked without the written authorization of **PICKETT EQUIPMENT**.

Damages resulting from rocky conditions are not covered by this warranty.

PICKETT EQUIPMENT does not warrant commercial components not manufactured by **PICKETT EQUIPMENT**. But, if new, these components may be warranted by the manufacturer thereof.

The only remedies any purchaser has in connection with the breach or performance of any warranty of Pickett Farm Equipment are those set forth in this warranty. In no event shall **PICKETT EQUIPMENT** be liable for incidental or consequential damages or injuries including, but not limited to, loss of crops, loss of profits, rental of substitute equipment or other commercial loss.

This warranty is expressly in lieu of any other express or implied warranties including any implied warranty of merchantability or fitness for particular purpose and of any other obligation on the part of **PICKETT EQUIPMENT**.

PICKETT EQUIPMENT makes no warranties, representations or promises, express or implied as to the quality or performance of Pickett Farm Equipment other than those set forth in this warranty. Neither the dealer nor any other person has any authority to make any representations, warranties or promises on behalf of **PICKETT EQUIPMENT** or to modify the item manufactured or sold by **PICKETT EQUIPMENT** or any other time unless he delivers to the purchaser a separate written warranty specifically warranting the same, in which case **PICKETT EQUIPMENT** shall have no obligation thereunder.

PICKETT EQUIPMENT parts, which are furnished under this warranty and properly installed, shall be warranted to the same extent as the original parts under this warranty if, and only if, such parts are found to be defective within the original warranty period covering the original equipment.

No warranty request will be considered, and **PICKETT EQUIPMENT** will have no liability under this warranty, unless the Pickett Equipment Delivery Checklist and Warranty Registration Forms have been properly filled out and returned to **PICKETT EQUIPMENT**, at Burley, ID. **PICKETT EQUIPMENT** warranty forms must be filled out with every claim. Claims must be submitted by the dealer to Pickett Equipment's home office. All warranty work must be completed within 30 days of failure. No claim will be accepted for warranties that exceed this 30 day period.

Warranty Disclaimers

The following conditions will void the warranty for the Twin Master Combine

Removing *safety* shields, guards or safety instructional stickers

Using tire sizes other than those standard to Pickett Equipment

Not maintaining or operating equipment according to Operator's Manual

Operating equipment in a malicious or reckless manner

Using replacement parts not of Pickett Equipment origin

Making modifications to the equipment other than those recommended by Pickett Equipment

Changing combine wheels around for a wider profile

Not signing and sending in the warranty registration to Pickett Equipment within 30 days of delivery

Pickett Equipment will strive to make product improvements every year, but we cannot be responsible for making updates or additions to equipment previously sold



TWIN MASTER

PREDELIVERY INSPECTION AND SET-UP And ANNUAL MAINTENANCE INSPECTION CHECKLIST

Note: Items highlighted with *asterisks represents new combine predelivery inspection and set-up. This service should be performed by either Pickett service personnel or authorized Pickett dealer service personnel. Items without *asterisks are a guide to routine annual maintenance that could be done on the farm or by any authorized Pickett dealer. Items with **asterisks apply to both.

1.	*Remove all uninstalled parts from the bin.
2.	*Install wheels and tires on axle.
3.	*Lift the main combine frame and lower onto the axle (long side of the axle on the right). Secure the axle to the combine frame.
4.	*Lift bin allow bin lift rams to rotate down along the combine side and lower the bin onto the combine main frame. Secure bin frame to the combine main frame.
5.	*Attach bin lift rams to the combine main frame. Attach hydraulic hoses to the lift rams. Counter balance valve goes on the lower ram port.
6.	*The remaining bin covers and the bin chutes can now be installed.
7.	*Attach the pickup head and platform to the front of the combine main frame.
8.	*Connect the radial pin clutch driveline to 90° gearbox and to transition auger stub shaft.
9.	**Check sprockets and chain on left main threshing cylinder shaft to 90° gearbox. Ensure alignment, tighten and secure. Check chain tension. Inspect 90° gearbox oil level.
10.	** Inspect 45mm bearings on the transition auger upper drive stub shaft.
11.	**Install guard over transition auger driveline.
12.	*Install pickup head lift rams and hoses.
13.	Check upper and lower transition auger sprockets for alignment. Check idler bearings. Check chain idler alignment. Check chain tension.
14.	Inspect bearings on both ends of transition auger, star auger, round roller and pickup head.
15.	**Inspect belt and belt tension from star feeder drive pulleys to round roller on pickup head.
16.	Lubricate pickup head drive chain and adjust chain tension. Check sprockets for alignment and tightness.

17.	**Inspect pickup head assembly, cam bearings, cam track, rubber pickup teeth and finger rod connections.
18.	Install hold down tube and hold down rods to the front of the pickup head.
19.	**Inspect star feeder. Rotate by hand listening for misalignment of stripper bars.
20.	Inspect bottom of star feeder housing for damage. Repair as needed.
21.	**Install star feeder motor and couple to star feeder shaft with chain coupler. Check for alignment and tighten set screws on chain coupler.
22.	*Assemble ladders and handrails to platform.
23.	**Check transition auger motion sensor for proper placement. Distance should be 1/8" between sensor and sprocket for correct sensing.
24.	**Install gauge wheels to the pickup head. Check pickup head gauge wheel tire pressure. Recommended pressure is 24 PSI. Inspect gauge wheel bearings. Lubricate and replace as needed.
25.	*Lift upper bucket elevator legs into place (use care to raise both legs at the same time to avoid damage to the driveline or remove the driveline) and secure with provided fasteners.
26.	*Connect bucket elevator chain and ensure proper alignment. Connection can be done through the leg cleanout covers at the bottom, front, and rear of each elevator leg.
27.	*Install bucket elevator drive motor, use care to ensure free movement of the motor mount. Use Loctite to secure the clamping coupler fasteners.
28.	**Adjust bucket chain tension. Tensioners are located on each side of upper elevator leg. Ensure that shaft placement is perpendicular to the bucket chain. (1/2" to 3/4" deflection in the chain is needed).
29.	*Connect leveling auger motor hose quick couplers.
30.	**Check all hydraulic valves, lines, and fittings for leaks.
31.	**Check all hydraulic motor coupler connections, star feeder, shaker motor, bucket elevator motor and leveling auger motor.
32.	Inspect all hydraulic cylinder pins. Lubricate as needed.
33.	**Check all electrical lines and components to lights and monitor system. Ensure they are clean and securely fastened to framework.
34.	**Inspect main tire pressure, left hand tire 24 PSI, right hand tire 40 PSI. Ensure that all main wheel lug nuts are tightened. Inspect main hubs. Inspect hub bearings by removing dust cover. Lubricate bearings as needed. Inspect hub bearing preload (with weight off of tire) by tightening castle nut firmly, while rotating by hand, and then backing off tension by approximately 1/4 turn or to next notch on castle nut. Replace dust cover repeat on other side.
35.	*Install straw discharge chutes. Connect drive belts to the straw choppers and adjust tension. Place guards over straw chopper drive belts. Check oil level in the 90° gear boxes.
36.	*Install straw spreaders to the discharge chutes.

37.	Inspect shaker table leaf springs. Replace any damaged leaf springs. Ensure table is level in relation to main frame. Tighten securely to mounts using grade 5 bolts and heavy-duty flat washers. Use lock nuts, double nuts or whiz-type nuts.
38.	Check shaker table eccentric connection to shaker table. Ensure that fasteners are secure. Lubricate bearing anchor points. Inspect eccentric bearings and grease as needed. Inspect eccentric drive shaft flange bearings and lubricate as needed.
39.	Remove straw walker and elevator leg sprocket shield. Inspect elevator leg and straw walker chains and sprockets for alignment and tension.
40.	Remove left and right shaker table inspection shields. Check straw walker tines for even placement between shaker table dividers.
41.	**Replace all shields.
42.	**Inspect final shaker screen. Ensure proper screen operating position (approximately 1/4" higher in rear). Ensure that all tilt-adjustment bolts are securely fastened.
43.	Inspect the bumper bar to ensure proper placement and working condition. The correct position is to have the center of the bumper bar approximately 1/4" above the top of the final shaker screen so that contact is made with the top corner of the screen.
44.	**Inspect vacuum setting. Recommended initial setting of vacuum adjustment plate is at its midpoint.
45.	Inspect turbine blades and vacuum shroud for wear, build up and tightness. Remove rear pulley shields to expose vacuum inspection plate located behind the upper drive pulleys. Loosen nuts and rotate plate. Use a flashlight for inspection of turbine blades and vacuum shroud. Or remove the fan housing top cover for a more thorough inspection. It is important to keep turbine fan blades free of buildup to ensure fan balance. Inspect shroud and turbine fan for normal wear. Replace as needed. When replacing turbine fan blades replace all blades to maintain balance.
46.	Inspect vacuum drive belt for alignment. Inspect belt tensioner (idler) bearings. Lubricate as needed. For bearing replacement, use high speed needle bearings.
47.	Inspect bin leveling augers. Inspect the hydraulic motor drive sprocket and both auger shaft sprockets, chain, and idlers for alignment and tension. Check all auger shaft bearings.
48.	*Hook up tractor to combine according to instructions found later in this manual (page 19).
49.	*Install primary driveline. Always connect shield chain to a secure location.
50.	**Remove cut-out clutch guard and inspect the cut-out clutch and connection to intermediate shaft. Recommended clamping cone bolt torque is 75 foot pounds. Grease bearing and replace cut-out clutch guard. Attach shield chain to a secure location.
51.	*Install the Ag-cam monitor and the touch screen monitor in the tractor's cab.

52.	*Hook the electrical system of combine to tractor. Ag-cam monitor and the touch screen monitoring system can now be tested.
53.	**Hook up hydraulic lines to tractor for initial startup and testing. Raise bin dump system. <u>IMPORTANT!</u> Inspect distance from elevator leg to bin chute prior to lifting bin. Ensure that a safe margin is maintained while lifting. The bin is equipped with a pressure relief valve on the rams down stroke. Maintain this down pressure at 500 PSI or less. While raising bin, check for hydraulic leaks.
54.	**Inspect threshing pin placement and tightness. Rotate threshing cylinders by hand to observe pin clearance to concave bars. Recommended minimum clearance is 1/2" to 3/4". In normal conditions operate with pins at the bottom of the pin pocket. (See pages 29 & 30.)
55.	**Test pickup head lift and drop. Adjust tractor hydraulic flow to regulate pick up head lift and drop speed. Set pickup head teeth ground clearance to 1" by adjusting gauge wheels.
56.	**Test the hydraulic motor circuit. Motors operate in following series: 1) Pickup Head, 2) Shaker Table, 3) Bucket Elevator, and 4) Leveling Auger. Check and remedy all hydraulic leaks. Begin slowly to observe for misalignment or restrictions. Operate shaker table at approximately 340 RPM. Using touch screen monitor turn pickup head on and off to ensure it is operational.
57.	**Inspect 2 speed transmissions, check oil level, drive belt alignment and tension, and coupling sprockets and chains.
58.	**Inspect swivel gear box mounts for loose bolts. Check oil level – top & bottom sections have separate oil levels. Oil level plugs are located on the tractor side (below center) of the gear boxes.
59.	**Test run all drive train components by slowly engaging the PTO. As the PTO is engaged, threshing cylinders, vacuum fans, and straw choppers can be tested. Listen, feel and inspect combine for any abnormal sounds or vibrations. Adjust and remedy as needed.

Combine Serial #

Customer or Dealer

Service Department or Technician

DELIVERY CHECKLIST

Review the Operators Manual with the customer. Explain the following:

- Pickett Equipment Warranty.
- Warranty disclaimers.
- Safe and correct operation and service.
- Tractor wheel adjustment, to ensure that the tractor does not run on the windrow (See your tractor manual).
- Daily and periodic inspections.
- Correct machine servicing and maintenance.
- Explain wear items, including fan and shroud maintenance.
- Combine and tractor tire pressure.
- Correct machine transport procedure.
- Walterschied safety and service manual in addition to driveline operating instructions.
- Optional attachments that are available for special crop and operating conditions.
- Operator's manual and parts listings.
- Warranty registration including registration of unit serial number.
- Sending in Warranty Registration to Pickett Equipment.

Date Checked

Signature

AFTER SALE CHECKLIST

Dealer / Customer

It is suggested that the following items be completed and then checked sometime prior to operation.

- Inspect for loose or missing bolts.
- Run the machine to see if it is functioning properly.
- Ensure that all safety shields and all safety stickers are in place.
- Verify that all chains and belts are aligned and tightened correctly.
- Check to ensure that decals are intact and legible.
- Inspect for broken or damaged parts.
- Review the entire Operator's Manual with the customer and stress the importance of correct and regular lubrication as well as safety precautions.

Date Checked

Signature



SAFETY SIGN

This is a safety-alert symbol. When you see this symbol on your machine or in this manual, be alert to the potential for personal injury.

Follow recommended precautions and safe operating practices.



DANGER

- **Observe overhead obstacles when raising dump bin**

Peligro

Antes de accionar la tolva de descara fijense que no haya obstaculos sobre esta



DANGER

- **ROTATING DRIVELINE KEEP AWAY**
- Contact can cause death
- **Do not operate without--**
- All driveline guards and equipment shields in place
- Drivelines securely attached at both ends
- Driveline guards that operate properly













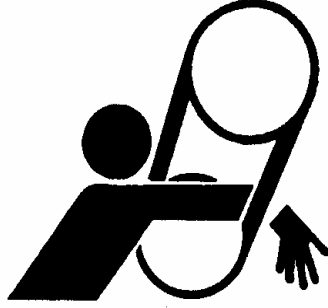

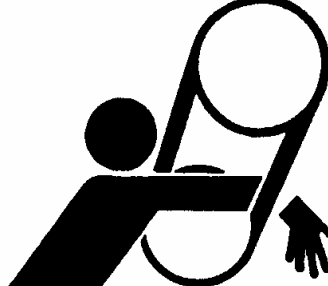

Warning

CRUSHING HAZARD

- To prevent serious injury or death
- Do not work beneath the bin while in the raised position, while tractor is running or counter balance valves are missing. See page 35.
- Always use mechanical safety locks.
- Tongue stand must be in place while connecting or disconnecting from the tractor.

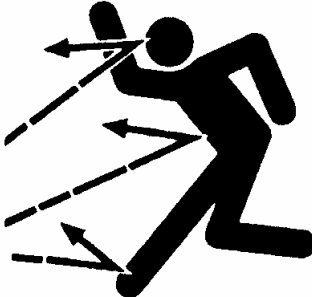
	 <h2 style="text-align: center;">Caution</h2> <ul style="list-style-type: none"> • High pressure oil leaks can penetrate the skin causing serious injury & gangrene. If this injury occurs consult a physician immediately. • <u>Do not</u> use fingers or hands to check for hydraulic oil leaks. • Release pressure before loosening hose fittings, always work with cool hydraulic oil.
	 <h2 style="text-align: center;">Peligro</h2> <ul style="list-style-type: none"> • <u>Conserve alejado de el cardan en operacion</u> • <u>Alejese!</u> El contacto con este puede causar injuria o muerte. No opera sin! Que el cardan se proteccion del cardan y laminas de proteccion se deben de mantener en su lugar. Asegure que el cardan esta bien instalado a el tractor y combinada. Piezas de seguridad del cardan giran entre ellos mismos. Asegurarse que la proteccion de seguridad del cardan opera en su forma debida.
	 <h2 style="text-align: center;">ADVERTENCIA</h2> <ul style="list-style-type: none"> • <u>PELIGRO de Astamiento</u> • Para prevenir sérias lesiones o muerte. No trabaje bajo la tolva cuando este en posicion de descarga a menos que se cilindro en su posicion correcta. • El estante o soporte del jalon de la cosechadora se debe de ajustar a la altura requerida antes de conectarse o desconectarse al tractor.
	 <h2 style="text-align: center;">Precaucion</h2> <ul style="list-style-type: none"> • Fugas de aceite de alta presion al tocar la piel causa sérias lesiones o cangrena. • Sérias lesiones o cangrena. Si esta lesion ocurre, consulte a su medico inmediatamente. • No use dedos o manos para revisar por posibles fugas de aceite hidraulico. Elimine o reduzca presion en el sistema hidraulica antes de aflojar las conexiones de mangueras y cuando el aceite este frio.

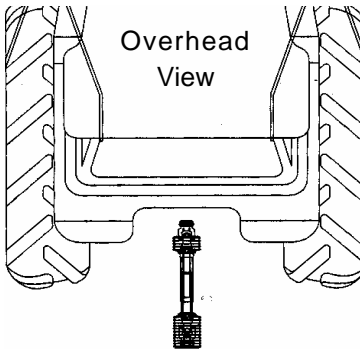
	<p> Warning</p> <p><u>Crushing hazard</u></p> <p>Do not place hands, fingers, or arms inside separating area while combine is in operation. Hands and fingers may become subject to serious injury.</p>
	<p> DANGER</p> <p><u>Shield Missing Do Not Operate Combine</u></p> <p><u>No Opere la combinada sin sus laminas de proteccion.</u></p> <p><u>Keep all shields in place</u></p>
	<p> DANGER</p> <p><u>Combine must be shut off to make changes in cylinder</u></p> <p><u>Peligro</u></p> <p>La combinada debe de estar apagada al hacer cambios al cilindro de trilla</p>
	<p> DANGER</p> <p><u>Combine must be shut off to make belt adjustments</u></p> <p><u>Peligro</u></p> <p>La combinada debe de estar apagada al hacer ajustes a bandas o correas</p>

	<p> DANGER</p> <p><u>Riding equipment may result in serious injuries</u></p> <p><u>Peligro</u></p> <p>Subiendose a maquinaria en operacion puede causar sérias lesions</p>
	<p> Caution</p> <p><u>Beware of flying objects from the rear of combine</u></p> <p><u>Precaucion</u></p> <p>Tenga precaucion con los objetos saliendo de la parte trasera de la combinada</p>
	<p> Important</p> <ul style="list-style-type: none"> • Tight turns may cause driveline damage <p><u>Importante</u></p> <ul style="list-style-type: none"> • Vueitas extremas del tractor puede causar danos a el cardan
<ul style="list-style-type: none"> • <u>Refer to owners manual for all lubrication points</u> Dese referencia a el manual de operacion para puntos de <u>lubricacion</u> 	
<p><u>Important</u> <u>Lubrication</u> <u>site</u></p>	<p><u>Importante</u> <u>Sitio de Lubri-</u> <u>cacion</u></p>

Introduction

It is important, and informative, for the operator to take a few minutes to read and become familiar with this operators manual. It contains the necessary information to safely and effectively operate this combine, along with the adjustments and settings for varying conditions. This manual should become a permanent part of your machine and kept within reach, should question arise.

**Left hand
side of
combine**



**Right hand
side of
combine**

Rear view



Right front view

General Operation and Startup Instructions

*The following information is provided to assist in the set-up of your **Twin Master Combine**. Also described are the proper functions and maintenance guidelines.*

1. Inspect all electrical lines and components. Make sure they are fastened securely and are free from any damage. Plug the Touch Screen Monitor and the AgCam Monitor into tractor's 12-Volt power source. (Note: 12-Volt power is converted to 24-Volt to operate the Touch Screen Monitor and PLC (programmable logic controller) while output to tongue tilt valve and pickup head speed control valve remains 12-Volt).
2. Check all hydraulic connections and fittings. Check for leaks and make sure all hoses are positioned correctly and free from damage.
3. Check all belts, chains, pulleys, and sprockets for alignment and for tightness. Operate all belts on the combine tight enough so they do not chatter.
4. Grease bearings that require grease (do not over grease). Most bearings only require minimum grease. Lubrication locations and amounts are located in the Lubrication and Maintenance section of this manual.
5. Inspect primary, secondary and tertiary drivelines for lubrication and make sure they are securely fastened especially the clamping cone on the Secondary Driveline. Torque cut-out clutch side clamping cone bolt to 75-ft. lbs. Make sure all setscrews and bolts are securely fastened. Driveline plastic guards need to be well greased and have shield chains securely attached.
6. Inspect pickup head for any loose bolts or broken parts. Inspect gauge wheel height to ensure pickup head is operating level and the teeth are working approximately 3/4" to 1 1/2" above the soil surface.
7. Inspect feeder house star tines and scraper plates for alignment and tightness.
8. Inspect the combine from front to back while hooked to the tractor to **make sure it will operate level.** Use adjustable tongue height on combine tongue and the tractors draw bar adjustments to achieve this task. An assist chain from the lower 3 point arms to the drawbar will help accomplish this. **Removing the three point quick hitch is recommended.** (Refer to Setting Up The Tractor page 19.)
9. The swivel gear box allows the tractor to be operated to the side of the windrow. Care must be used when setting up the gear box stabilizer assembly. It must keep the lower part of the swivel gear box aligned with the tractor without binding. Operating the combine with as little offset as possible will length driveline bearing cross life.
10. The Twin Master requires 4 hydraulic outlets on the tractor. The # 1 remote controls the raising and lowering of the pickup head. Regulate the flow of oil from the tractor so pickup head lifts smoothly and slowly. For added transport height the front of the combine can be tilted up (this feature is blocked by the electric on/off switch during field operation). With the electrical switch in the on or unlocked position the pickup head will

raise first then the machine will tilt. **Do not operate the tilt function unless the dump bin is empty.** The # 2 remote will operate the rotation of the pickup head, feeder house, shaker table, bucket elevator and leveling augers in the bin. To adjust hydraulic flow to this series of hydraulics, turn the shaker table flow control knob counter clockwise (Located on the shaker table hydraulic motor on the left side of the combine) to Full on (counter clockwise). Then adjust the hydraulic flow of your tractor down to a low flow rate, and turn on. Using the combine's monitor system RPM read out adjust the tractor's flow control until the shaker pan shaft speed is 350 RPM. Then using the flow control located on the shaker motor to adjust the speed to 340 RPM. Then using the flow control on the bucket elevator motor set this speed to 110 RPM. This should provide plenty of oil for the other operations without having more oil flow through the system than required (excessive flow causes excessive heat). Set the pickup head speed control were the pickup head speed does not exceed 1/2 operational ground speed. The # 3 remote controls the pull tongue swing movement, keep tractor flow turned low to have slow steady movement. The # 4 remote controls the raising and lowering of the bin. A pressure relief valve is located on the bin down stroke to regulate the pressure and not damage the bin or combine frame. This relief valve should be set to 500 PSI or less. **Do not transport or operate combine, unless bin is in retract or down position.** To determine the distance between the truck to the combine for unloading, position outer edge of dump bin straight up from side of truck box. Having an indicator rope will help with this operation. Regulate the flow of oil, so bin raises and lowers safely and slowly. Make sure the tractor hydraulic control levers are working properly and in a direction the operator is familiar with. Changing positions of the hydraulic hoses in the tractor remote will change direction of travel. **Always have combine directly behind the tractor before backing or transporting.**

11. The vacuum fans are located in the upper rear position of the combine and are powered by a belt system, driven by the main PTO drive. Two sizes of pulleys are used on the upper shaft. The small pulley is used when operating with the 2 speed transmission in low range. The larger pulley is used when operating with the 2 speed transmission in high range. This pulley change is necessary for best results in vacuum suction. After changing pulleys move belt tension idler to the correct mounting holes to achieve proper belt tension. Vacuum air ports are provided for easy inspection of the fan and are directly below the pulley driving each vacuum fan. Inspect the fans daily, especially in high moisture situations. Build up on the fan at high speeds can cause imbalance and fan failure. When material is noticed on the fan blades it must be cleaned off for safe operation. Remove the top fan housing cover to clean fans.
12. Inspect bucket elevator chains for tightness and adjustment. 110-115 RPM is the optimum bucket elevator speed to help prevent damage to crop.
13. The transition auger, feeds the material to the central flow cylinders. The speed is regulated by the speed of the threshing cylinders and no adjustment is required.
14. Cylinder speed and threshing pin placement can vary, depending on field conditions from wet to dry. The concept of the cylinder using centrifugal force and higher speeds give the cylinder its low impact capabilities. As the product moves through the cylinder the threshing pins can be turned and positioned to change the amount of threshing time necessary for threshing and separating the crop. (Refer to Combine Cylinder Adjustment page # 29.) Threshing pins are spaced evenly on the auger fighting of each cylinder. It is

important to keep the cylinders balanced, when adjusting the threshing pins. Start up setting: (Refer to Combine Cylinder Startup Settings page # 30). In normal conditions pins are set to the bottom of the pin pocket. If concave holes are being blocked by a mat of grass or other debris extending a few pins closer to the concave near the rear will help keep the concave clean. Cylinder speed and threshing pin placement need to work together for efficient separation. Increased cylinder speeds can cause more crop seed damage, while a slower cylinder speed will likely reduce damage. The Twin Master is equipped with two heavy duty 2 speed transmissions that reduce the tractors 1000 RPM PTO to 540 and 390 RPM or 500 and 350 RPM. (Depending on transmission option installed.) By changing the tractors RPM and shifting the transmission you will be able to obtain a wide range of threshing cylinder speeds. The two transmissions shift with one shift lever located on the right side of the machine.

IMPORTANT: As RPM on cylinder decreases so does the suction of the vacuum fans. It becomes a necessity to adjust the vacuum cover plate with a change in cylinder RPM.

15. The crop and chaff pass through the concave onto the shaker pan. The crop moves over the shaker pan toward the rear of the combine where the vacuum system removes impurities through the vacuum fan. Adjust vacuum by moving the cover plate above final screen. Using a 15 mm wrench loosen nuts on each side of the vacuum plate. There is one plate on each side. Keep the plate level. Moving the plate higher above the final screen reduces the suction. Start by setting the plate midway. To fine tune visual inspections are necessary. With combine in operation, watch in the area under the vacuum duct (by use of the AgCam) where the beans pass over the shaker table to the final screen. If beans are floating or bouncing up, the vacuum is too high. Raise each side of the plate equally in 1/2" increments until the beans start to settle and you can just see the crop barely raise off the table. Lower the plate if chaff and other foreign material aren't being separated from the crop.
16. Two final screens are standard with each combine, 9/16" round and 1/2" x 1" oblong. Check with your dealer to see what special order sizes may be available. Product size will determine final screen size selection to use. There are 2 fasteners on each side and 2 in the middle of the final screen to maintain proper screen tilt. (Refer to Combine Shaker-Separator and Final Sieve pages # 31 & 32). Operate screen level or 1/4" to 1/2" higher in rear. If crop is going over the back of the screen, use a larger screen size. Lift the rear inspection flap to make sure the final screen is level (side to side). A bumper bar system provides a jolting action to shaker table and is located on rear of final screen to keep dirt clods and other materials from clogging up the screen. Adjust the bumper bar so that the center of the bar is slightly above the top final screen so contact is made with the upper rear corner of the final screen.

Lights and Signals



Combine lights are wired to come on when tractor light switch is turned on.

Lights must be turned on when transporting

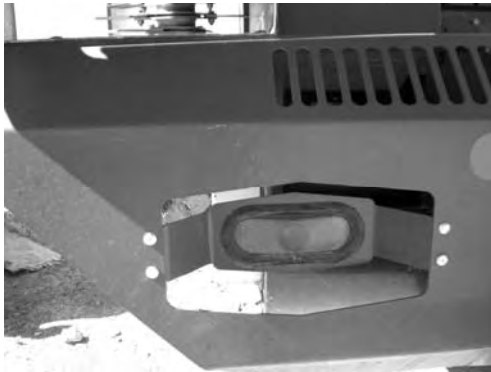

Combine signal lights operate with the Tractor turn signal lever.

When transporting on a road, flashing lights give warning to other drivers. These lights are located on both sides at the rear of the combine.



A work light inside the bin will give adequate lighting for night work.



A work light is positioned on the outer right front corner of the dump bin to aid in dumping the bin after dark.

Setting Up The Tractor



Tractor PTO Speed

The Twin Master is equipped with a 1000 RPM, 1 3/4" 20 spline (Walterscheid) driveline.

Clean and lubricate PTO shaft with high temperature EP grease before attaching PTO driveline.



Shield removed for illustration

Adjusting Drawbar

1. Adjust tractor drawbar to measure 20 in. from end of PTO shaft to center of the drawbar hole.
2. Adjust drawbar to 18-20 in. clearance from the top of the drawbar to the ground.
3. Position drawbar to align hitch pin hole with centerline of tractor PTO shaft. Do not pull combine in a offset position.

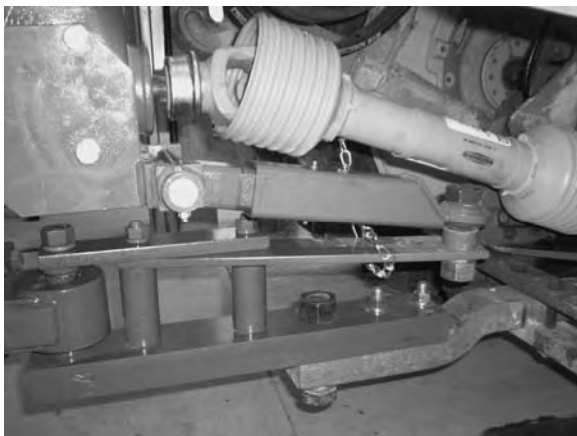

Swivel Gearbox Stabilizer

Assemble drawbar extension and swivel gearbox stabilizer as shown. Use care to determine that it will move in all desired positions without binding. Check daily for loose bolts and proper movement. Lube daily.

Shaft Monitor System

Pages 4 & 5 give information on the combine and monitor operation. Button advances you to the previous page.

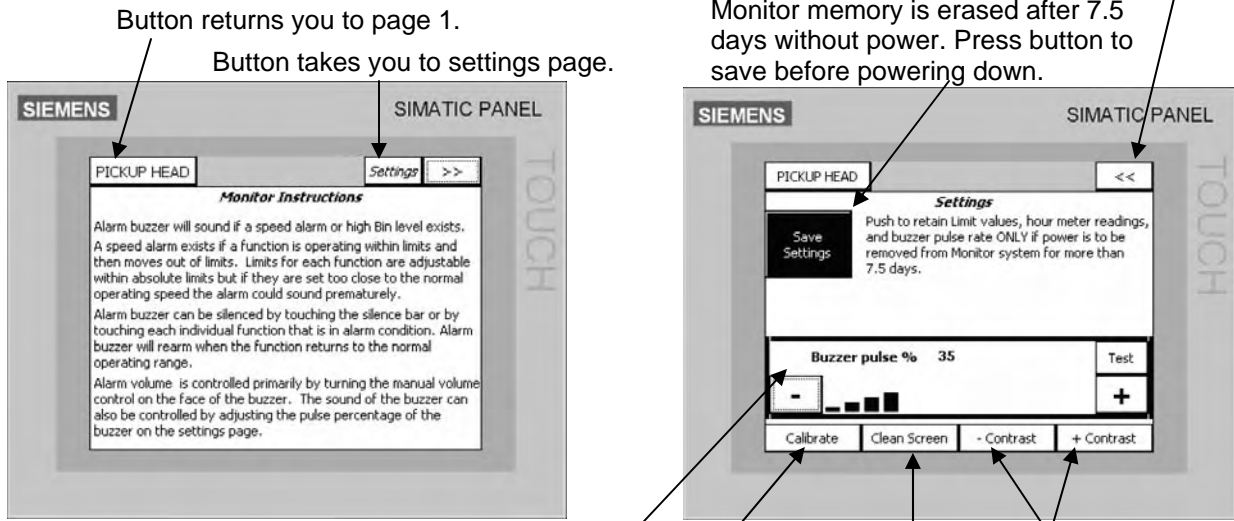

Button returns you to page 1.
Button takes you to settings page.

Monitor memory is erased after 7.5 days without power. Press button to save before powering down.

The sound of the alarm buzzer can be changed by varying the pulse percentage rate.

Contrast buttons allows the operator to change the screens brightness.

Calibration function needs to be performed after the scratch protective cover on the touch screen is replaced. Follow the on screen instructions. No other action can be taken during this process.

Clean Screen button gives you 1 minute to clean the screen. No action intentional or accidental can be taken during this time.

The pickup head speed is controlled by a proportional valve driver. The driver is controlled by a signal from the touch screen monitor.



Settings & Range:

- HI : high, output current corresponding to the highest input, 0.00 to 3.00 A (1.60)
- Jg : jog, used to simulate input
- LO : low, output current corresponding to the lowest input, 0.00 to 3.00 A (0.35)
- UP : ramp up, time required for the output to increase from LO to HI , 00.0 to 99.9 s (01.5)
- dn : ramp down, time required for the output to decrease from HI to LO , 00.0 to 99.9 s (01.5)
- db : deadband, output is disabled when command signal is less than this setting (0.50)
- dF : dither frequency, 50 to 500 Hz (100)
- in : input signal selection, 005(0-5V), 010(0-10V), 020(0-20mA) or 420(4-20mA) (010)
- di : display orientation, normal or up-side-down
- SA : save settings

(Factory Settings)

Set-Up Procedure:

At power up the display shows the input or output signal, selected by rotating #; the input directly in V or mA, corresponding to the input range pre-selected; the output current in A. To enter set-up mode rotate *, the display will show the settings sequentially: HI, Jg, LO, UP, dn, db, dF, in, di and SA. When you reach the setting that you want to modify, rotate up or down to the desired value. To modify another setting, rotate * again and repeat. The Driver is fully functional during the set-up procedure with any adjustments effective immediately (except the input range selection that becomes effective only after saving). In order to write the new settings in the memory and return to normal mode of operation, rotate * until the display shows SA and then rotate #. If you do not want to keep the new settings, you may disconnect and re-connect the Driver from the power supply.

Shaft Monitor System

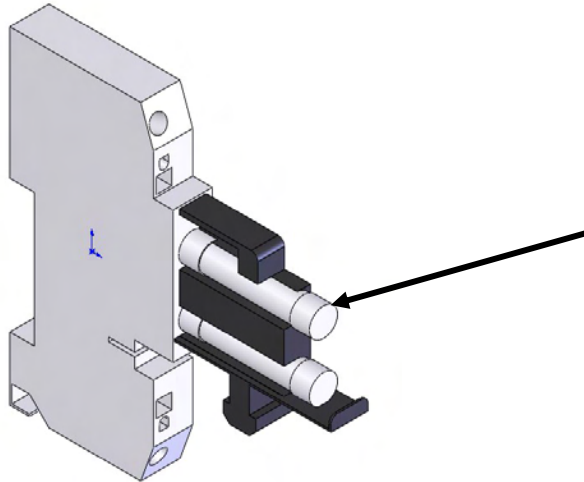

Each monitor system has 2 fuses located in the lower right hand corner of the white monitor enclosure. The one on the right is for the 12v to 24v power converter. The one on the left is 12v for the pickup head and the tongue tilt.

To change a fuse pull firmly on the black handle in the center of the fuse holder then press down on the handle rotating it 90°. Each fuse holder has two fuses in it. In the rotated position the lower one is a spare. The upper one is the one in use.

Fuse # GMA—15A
Pickett # 106083

AgCam System

NEVER RELY ON YOUR AGCAM AS A SAFETY FEATURE. It is up to your discretion to keep your road travel and other operations safe. Your AgCam will provide you with information only based on what it sees operation of machinery safety guidelines still apply.

AgCam Monitor Operation

Before turning you monitor on, make sure it is supplied with power and cameras are connected. Turn you monitor on by pushing the “power” (on the face of monitor or on remote). If you do not see a picture, you may need to switch to another video (camera) input selection by using the button marked “AV” on monitor and remote, depending upon the number of cameras being utilized.



1. Extendible antenna (analog).
2. **ANT:** external antenna jack.
3. **EAR:** earphone jack.
4. **MENU:** active OSD menu, press this key and select the setting object that you want to adjust with the help of the 8 or 9 button.
5. **-:** Volume (in OSD), press this key to turn down the volume and adjust the setting value of the menu.
6. **+:** Volume (in OSD), press this key to turn up the volume and adjust the setting value of the menu.
7. **CH+:** to select the program and the setting object in the menu.
8. **CH-:** to select the program and the setting object in the menu.
9. **AV:** to select the input signal.
10. **POWER:** On/Off/Standby
11. Audio/Video In (white band indicates audio enabled input)
12. Video In – 2nd Camera
13. Power Input (A/C or 12v)

AgCam System

Remote Control Functions for Monitor

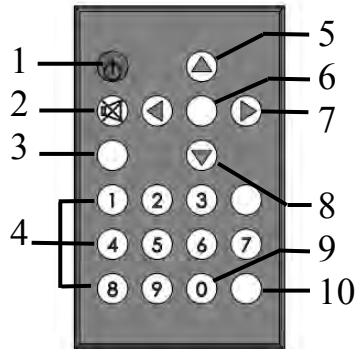

1. **Power:** On/Off/Stand by.
2. **Mute:** Press this key to close the sound, press it again to return the sound.
3. **AV/TV:** to switch between TV signal and Video Signal.
4. **Menu:** Active OSD menu, press this key and select the setting object that you want to be adjusted by the help of the 5 or 6 button.
5. **CH+:** Program selection.
6. **CH-:** Program selection.
7. **V-:** Volume (in OSD), press this key to turn down the volume and adjust the setting value of the menu.
8. **V+:** Volume (in OSD), press this key to turn down the volume and adjust the setting value of the menu.
9. Numbers buttons: **0-9**.
10. **Wide:** Select the display mode of image (16:9 or 4:3).

Menu Operation—To allow changes in the picture settings, press the menu key on the unit or remote. Use CH-/CH+ to select item (the selected item turns red) U V-/V+ for adjusting the value. Press Menu key to return to main menu. *Note*—if you stop operating the unit for a few seconds it will automatically exit out of the menu.

Video—Pressing the menu key will immediately bring you to the video menu to adjust brightness, contrast, color, sharpness or tint. You can do so by pressing the CH-/CH+ key to select which item you would like. Use the V-/V+ keys to adjust the value for any of these settings.

Audio—Next by pressing the V+ key you will go to the audio item. Press CH-/CH+ to select the volume and press V-/V+ to adjust volume.

Setup—To continue press V+ and this will bring you to the set up item. You can choose the language you desire, Chinese, English, Russian, German or French. Press CH-/CH+ to select then V-/V+ to change the language.

- To setup screen background setup press CH-/CH+ key to choose background, then press V-/V+ key to choose ON/OFF (when there is no signal, the background is blue.)
- To adjust the display state of the screen size press CH-/CH+ key to select "Mode" and V-/V+ to adjust. When you select "1" the display status is 16:9 (Full screen display), "2" it is 4:3, "3" is 16:9 in full screen display and "4" is 4:3 on the right.
- The unit has the function of image. "Up and Down Reverse" and "Left and Right Reverse". Use CH-/CH+ to select "UV Rev" or "RL Rev". Then press V-/V+ on the remote to control image of "Up and Down Reverse" or "Left and Right Reverse".

Tuner (Analog) - This TV has an analog tuner. You can use a conversion box to receive digital TV signal.

Complete Drive Train

Primary Driveline



Lubricate crosses every 8 hours

Telescoping members must be lubricated either through zerk in telescoping member or by taking apart every 8 hours

Lubricate guard through molded nipples every 8 hours

Attach guard safety chain to a secure location

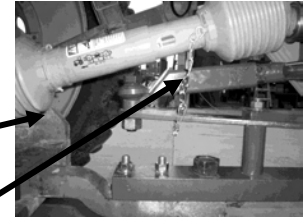

Secondary Driveline & Swivel Gearbox



All driveline crosses, telescoping members and plastic guards must be lubricated every 8 hours

Swivel gearbox use SAE 80W-90 (2 places on the tractor side of the boxes) check 25-30 hours

Cut-out clutch clamping cone bolt torque to 75 ft lbs. Cut-out clutch requires no service. If overload occurs disengage tractor PTO after it completely stops reengage slowly.

Attach guard safety chain to a secure location

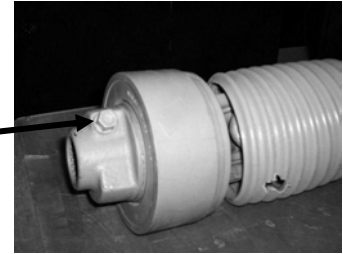

Tertiary Driveline & 2 Speed Transmission

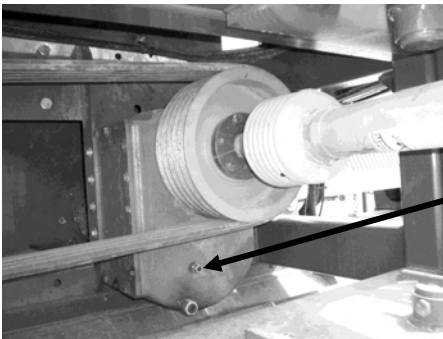

All driveline crosses, telescoping members and plastic guards must be lubricated every 8 hours

2 Speed Transmission use Synthetic SAE 75W-90 check daily oil level center of sight glass

Overrunning clutch is located at the forward end of the Tertiary driveline. Lube every 8 hours

Attach guard safety chain to a secure location

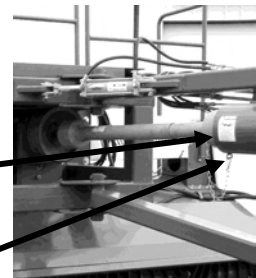

Note: Operating combine at maximum tongue offset angle will shorten driveline bearing cross life. Use minimum offset to keep tractor from running on crop.

2 Speed Transmission & Shifter

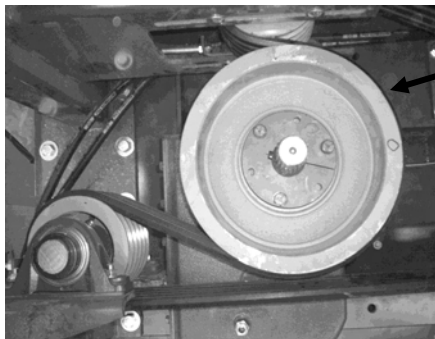

The right hand transmission is belt driven from the left hand transmission

Both transmissions are shifted by one shift lever. Do not force lever. The input side of the transmissions may need to be rotated to align gears.

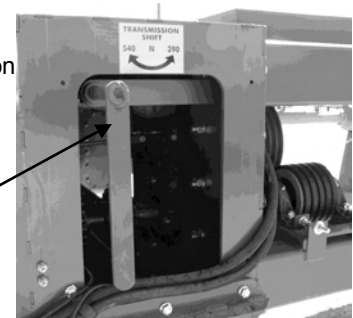

Feeder House

Transition (Feeder) Auger

Intermediate Star Feeder

8 Bar Pickup Head

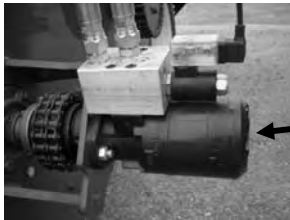
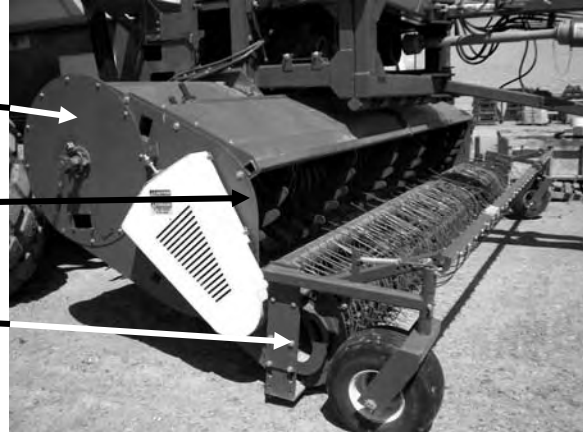

Variable speed with in cab control hydraulic drive for varying conditions, gentle handling and positive feeding of crop.



Adjustable hold down rods for smooth feeding.

Adjustable gauge wheel, allowing the pickup head to follow terrain.

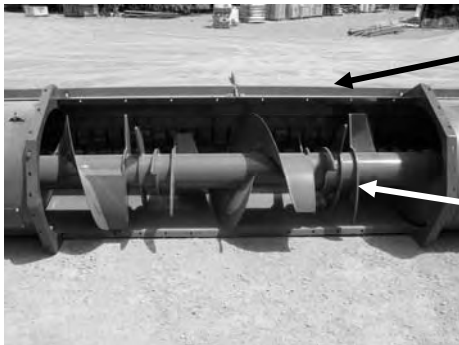

Complete feeder house shown removed from the combine.

Transition auger with deep flighting and heavy duty stars to move the crop gently into the threshing cylinder.



Transition auger drive, mechanically driven from PTO driveline.

Intermediate star feeder and pickup head hydraulic drive motor, variable from the tractor cab.

Feeder House

Transition Auger Drive

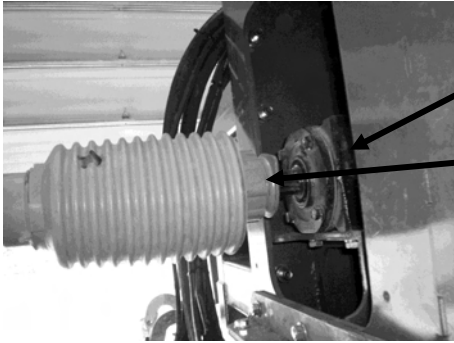

90° gearbox use Synthetic SAE 75W-90 check 25-30 hours.

The radial pin clutch needs to be lubricated each time it is activated.

All driveline crosses, telescoping members and plastic guards must be lubricated every 8 hours.

Transition Auger Drive

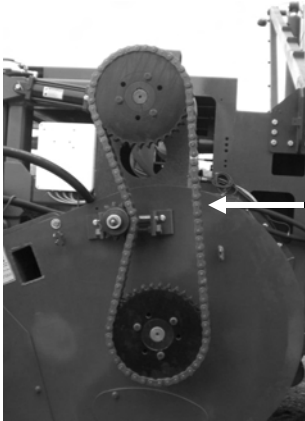

Transition auger is chain driven. Power comes from the left hand threshing cylinder.

The combine can be configured 3 different ways.

Slow down—30 on top and 36 on the bottom. This is used with fragile crops and extremely dry conditions.

1 to 1—36 tooth sprockets both top and bottom. This works best in normal conditions.

Speed up—36 on top and 30 on the bottom. This is best with hardy seeds and tough, green vines. This will give more power to the transition auger.

Pick Up Head Drive

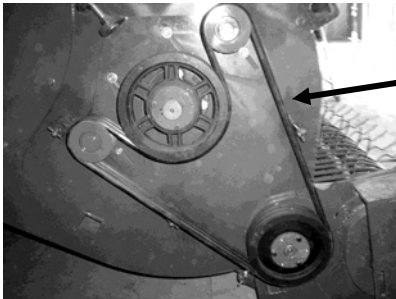

The pickup head is belt driven from the star feeder to the round roller.



The pickup head is chain driven from the round roller.



Adjustable Pull Tongue

The pull tongue can be adjusted to **keep combine level** for operation, regardless of the tractor drawbar height.

Pull tongue equipped with a heavy duty Dura-ball.

Concave Separator & Threshing Cylinder

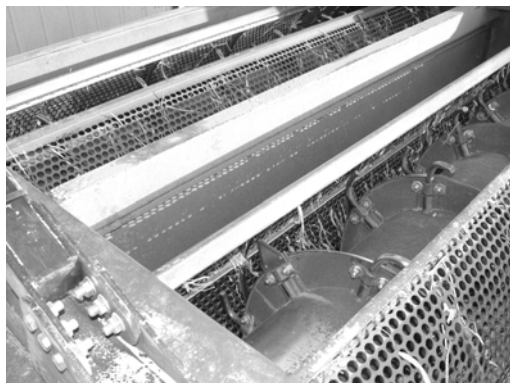

Concave Separator Sieve

The perforated concave allows the seed to fall to the shaker pan as soon as it is threshed out of the pod. Concave bars are located on the inside of concave.

The cylinder and concave are easily accessible by raising the bin.



The threshing cylinder is directly underneath the bin. The bottom of bin serves as a lid for the top of the threshing cylinder. When combine is operating the bin needs to be completely lowered enclosing the cylinder.

Low Impact Threshing Cylinder

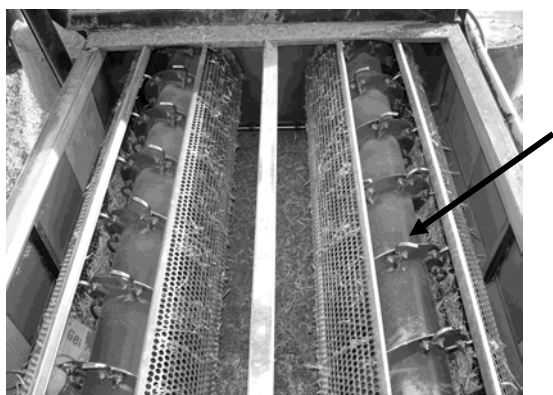

Cylinder threshing pins. These pins can be adjusted by loosening the carriage bolts that hold the clamp. With the clamp loose, pins are able to rotate, also move in & out. Rotating the pins forward, against the flow of the material, causes a slowing of material travel, thus increasing the amount of threshing in the cylinder. Rotating the pins towards the direction of material flow reduces threshing. Pins are normally all of the way down in their pocket. If concave holes are being blocked by a mat of material, such as grass, extending a few pins out, closer to the concave, and turning them toward the rear of the machine will help keep concave holes open.

Before making any adjustments to the combine cylinder
TURN OFF TRACTOR!!!
REMOVE KEY FROM TRACTOR IGNITION!!!
ALWAYS EMPTY BIN BEFORE MAKING ADJUSTMENTS!!!
ALWAYS ENGAGE MANUAL BIN SAFETY LOCKS!!!

Concave Separator & Threshing Cylinder

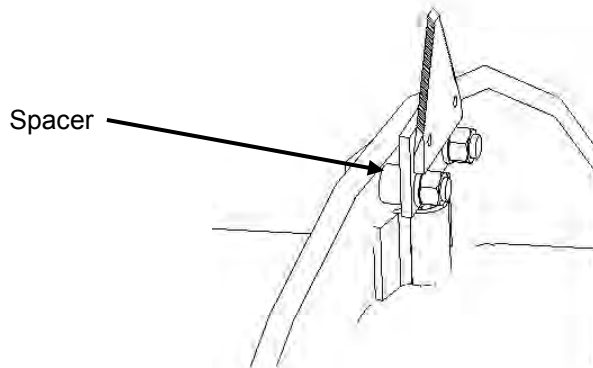
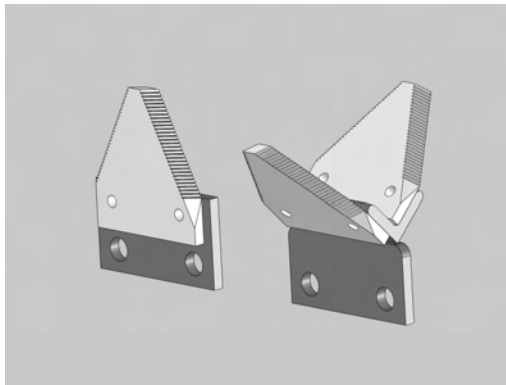

Two knives per cylinder come standard on all new combines, normally replacing the 1st and 4th pins. These knives cut, separate and distribute the material evenly in the front of the cylinder. Place the knife on the same side of the flighting as the pin would go use a 9/16" spacer as shown so that the knife cuts straight through the material. Two types of knives are available single blade and double blade. The only time that a double knife is recommended is when threshing very sporadic and inconsistent windrows. Knives will cut and separate the material more evenly, not only in the cylinder but coming out of the combine as well.

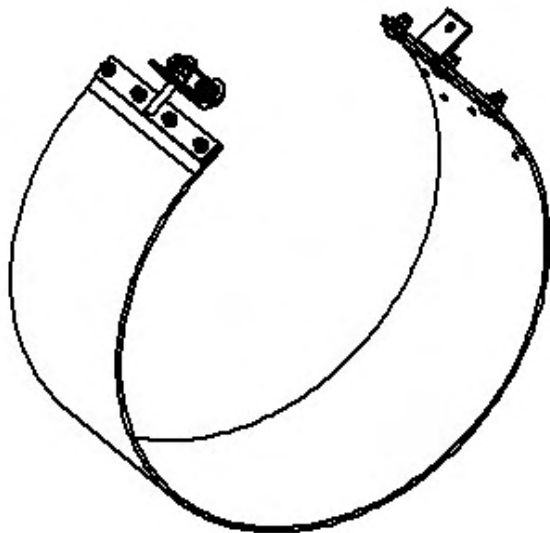

Concave cover belts come standard on all new combines. These cover belts will not allow whole pods to fall onto the shaker table. They will also hold the material in the cylinder longer helping to distribute the beans across the shaker table more evenly.

When the cover belts are not needed they can be folded in half and left hanging in the combine. The only time the cover belts are not recommended is in extremely weedy conditions, especially nightshade.

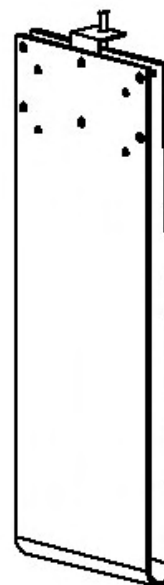

Warning

Before making any adjustments to the combine cylinder

TURN OFF TRACTOR!!!

REMOVE KEY FROM TRACTOR IGNITION!!!

ALWAYS EMPTY BIN BEFORE MAKING ADJUSTMENTS!!!

ALWAYS ENGAGE MANUAL BIN SAFETY LOCKS!!!

Combine Cylinder Adjustment

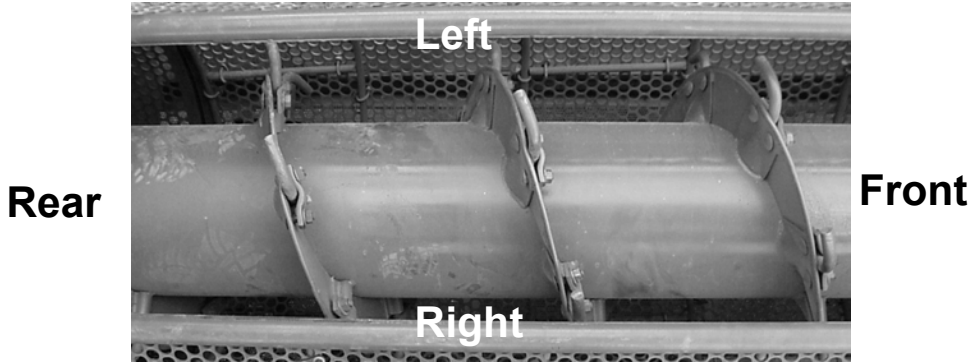

Combine main threshing cylinder with hardened threshing pins.

Above photo is of the left hand cylinder. The drawings below on the left are the left hand cylinder and drawings on the right are of the right hand cylinder. Direction of flow would be from the top of the page to the bottom of the page. **Degrees are referenced from a line perpendicular to the threshing cylinder tube.**

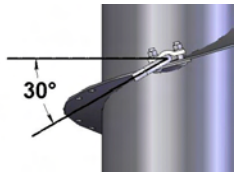

Threshing pins at the 30° rearward position
 Quick movement of material
 Neutral setting for gentle thresh

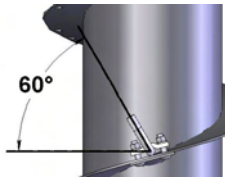
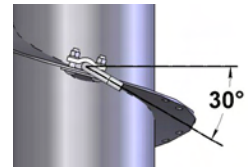

Threshing pins at the 60° forward position
 Slower material travel
 Hard thresh setting

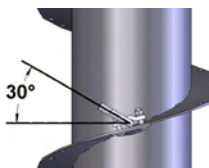
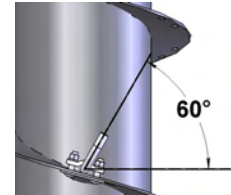

Threshing pins at the 30° forward position
 Medium material travel
 Medium thresh setting

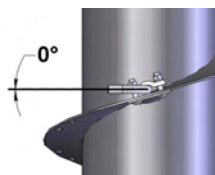
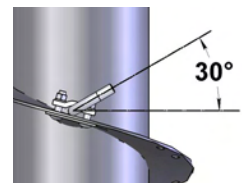

Threshing pins at the 0° or base line position
 Increased material travel
 Gentle thresh setting

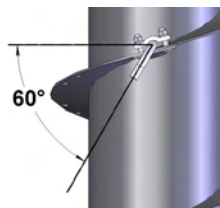
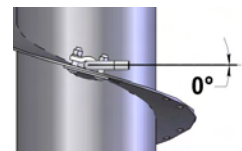

Threshing pins at the 60° rearward position
 Fast material travel
Extreme easy thresh setting

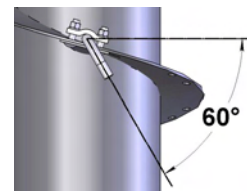

Combine Cylinder Startup Settings

It is important to understand the fundamentals of how the central flow threshing system works. This system does not rely on a hit or rub to dislodge the beans from the pod. This system uses centrifugal force to gently separate the seeds from the plant and move the seeds to the shaker table. This is why it is important to keep constant pressure or power in the threshing cylinder and by operating the threshing cylinder at a speed that will not damage the seed. Cylinder speeds of 290 to 360 RPMs in almost every case will deliver quality seed. This will allow the tractor to stay above 1800 RPM and keep the time required for recovery in the threshing cylinder constant. Operating the cylinder at higher speeds will not increase the capacity of the machine; however it will cause parts to wear out quicker. Capacity is determined by the amount of chafe and beans on the shaker table and final screen. With the aid of the AgCam determine that seed is never going beyond the middle of the final screen while in operation. This will allow the vacuum system to adequately remove the foreign material. Keep threshing pins in good condition; in most cases if beans are going out the rear of the machine, it is because the pins in the first two sections of the threshing cylinder are worn out and should be replaced.

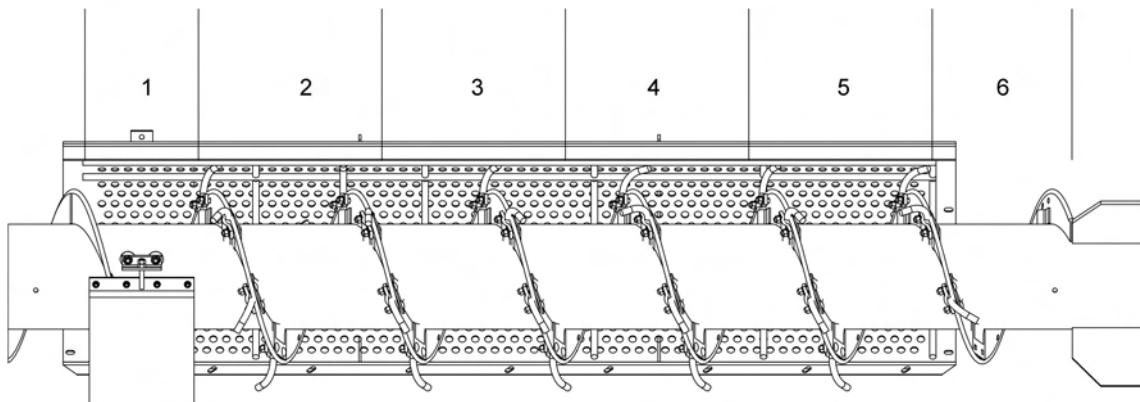

1. This is the knife and cover belt section. Knives normally replace pins 1 & 4. The remaining pins are set at neutral. The cover belt will not allow whole pods to fall onto the shaker table. It will also hold the material in the cylinder longer and help distribute the beans across the shaker table more evenly.
2. This section is where the threshing begins. Set 3 to 5 pins at 0° to 30° forward, with the remaining pins set at neutral.
3. This is where the majority of the separation takes place. Set all pins at neutral, at this time most of the seeds are on the shaker table being polished by the leaves.
4. This is the stirring section. Set 3 to 4 pins alternately at 60° forward and 60° rearward with the remaining pins set at neutral. This creates an irregular motion in the material allowing the seeds to separate from the straw.
5. This is the final separation and stirring section. Set the last 3 to 4 pins alternately 60° forward and 60° rearward with the remaining pins set at neutral.
6. This final section is the discharge. All pins should be removed from this section. The last pin in the cylinder should be where the last concave bar is located.

Before making any adjustments to the combine cylinder

TURN OFF TRACTOR!!!

REMOVE KEY FROM TRACTOR IGNITION!!!

ALWAYS EMPTY BIN BEFORE MAKING ADJUSTMENTS!!!

ALWAYS ENGAGE MANUAL BIN SAFETY LOCKS!!!

Combine Shaker-Separator



Shaker Pan Area

The shaker pan should be operated at a speed that allows the crop to move at a steady even flow. If the crop bounces up from the pan, the shaker speed is too fast. 340 RPM on shaker shaft is a good startup speed.

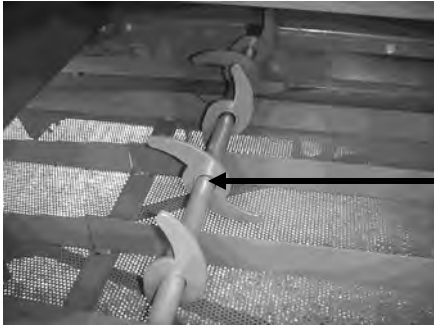

Straw Walker Shaft

The straw walker aids in the movement of the straw underneath the vacuum suction port. It also stirs the material allowing the heavier crop to fall below the lighter straw and chaff, allowing the vacuum to clean the crop more efficiently.



Shaker Pan Springs

The shaker pan should be centered in it's operating area so it does not come in contact with other parts during operation. There are 4 sets of 6 springs on each side of the shaker pan. This allows for proper shake of the pan and crop movement.



Vacuum Fan Adjustment Plate

The vacuum fan adjustment plate (1 per side) can be raised or lowered to change the amount of suction. The vacuum fan is positioned directly over the shaker pan for cleaning the foreign particles out of the crop, as the shaker pan moves the crop material directly underneath the vacuum at an even flow.



Final Shaker Sieve Adjustment

This sieve should operate on as low of an incline as possible, without the crop spilling over the back and still allow the large foreign materials to ride over the back of the sieve. This concept will work best for maximum cleaning and capacity.

Final Sieve

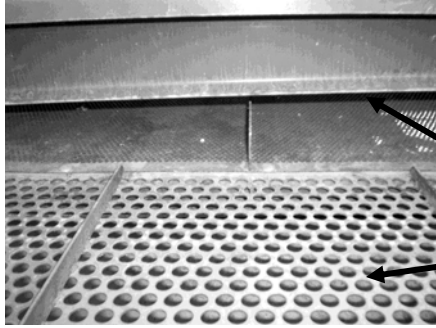

This is the final shaker sieve, where the last of the cleaning takes place before the crop is lowered to the elevator auger.

Vacuum adjustment over sieve area.

Final sieve.



The sides and middle of the sieve are slotted to allow the sieve angle to be adjusted. A slight incline in the rear will allow the crop time to fall through the sieve and larger material to shake off the end of the sieve.

Round hole style sieve.

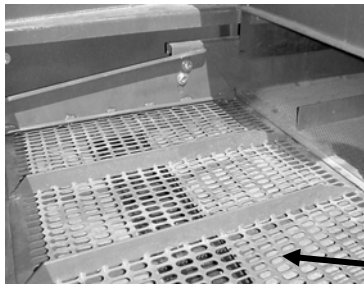

Two types and sizes of holes on the sieves are standard.

Round hole 9/16".

Oblong hole 1/2" x 1".

Round hole type sieve will work better in conditions where small dirt clods might be present.

Oblong hole style sieve

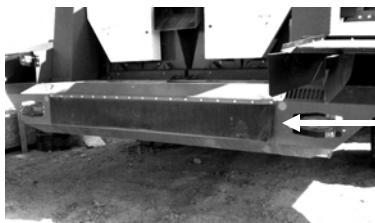

To remove sieves, remove the two adjustment bolts on each side, the two in the center and loosen the back row of bolts in the shaker pan, lift up rubber flap and pull sieve straight out.

An adjustable bumper bar is installed to add more vibration and shake to the final sieve. This extra action will help keep the small dirt clods from sticking in the sieve holes. Adjust the bumper bar so that the center of the bar is slightly above the top of the final sieve.

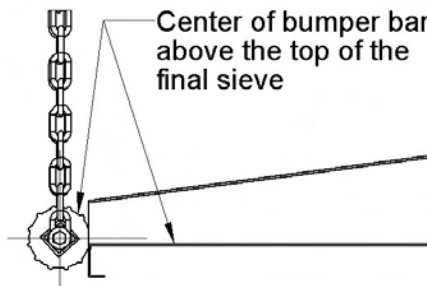
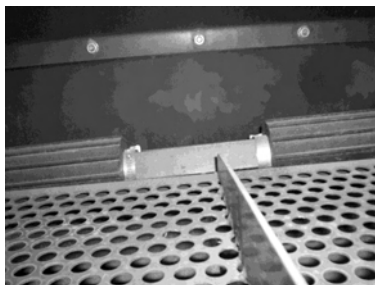

Vacuum Cleaning System

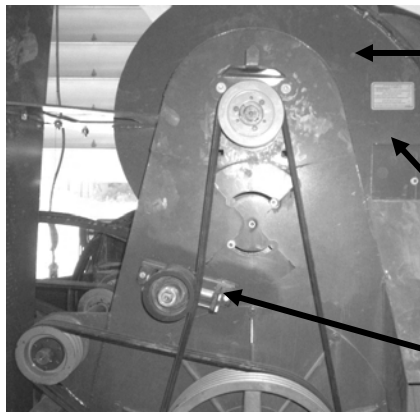

Vacuum turbine housing

Internal vacuum fan shroud

Vacuum fan inside

Vacuum drive belt tensioner

Vacuum turbine fan

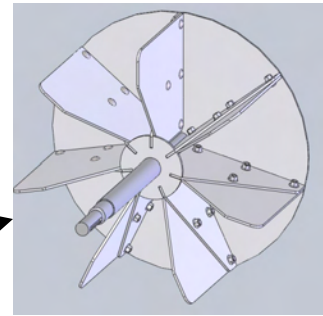
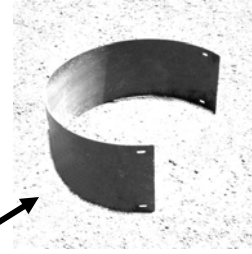

Vacuum turbine air adjustment plate

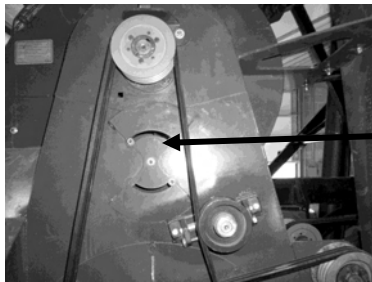

This door can be opened or closed to change the amount of vacuum suction. Open reduces and closed increases suction. This door also allows visual inspection of the fan and shroud for build up and wear.



Vacuum suction intensity adjustable plate.
One per side.

Make adjustments in 1/2 inch increments. Lowering plate too low will increase suction, and may cause excessive crop loss. Leaving plate adjusted too high may cause excessive trash in the final bin sample.



Lowering this plate will increase the amount of vacuum suction for removing foreign matter in the crop. Raising the plate will decrease the suction.

Bucket Elevator

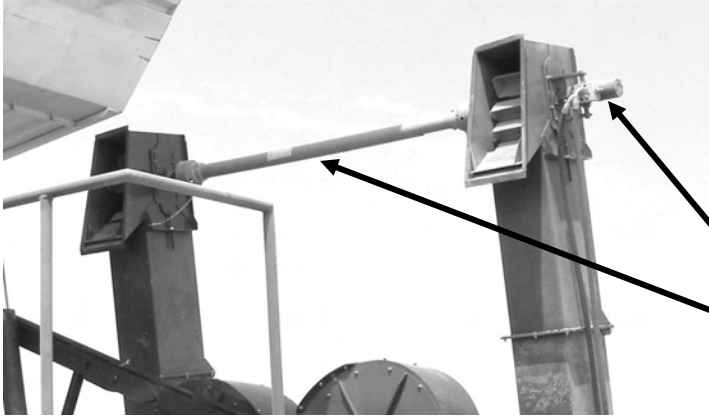

The bucket elevators are driven by a hydraulic motor on the top of the left hand elevator. The two elevators are connected together by a driveline.

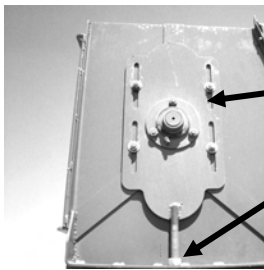

Elevator bucket chain tensioner & adjusting bracket. When tightening the bucket chain, both sides need to be adjusted evenly to keep the buckets centered. Do not over tighten the bucket chain. The chain should have approximately 3/4" deflection in or out from straight.

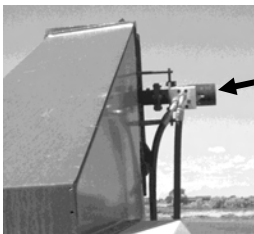

Hydraulic variable speed drive (with control at the motor) for bucket elevators, elevator cross augers and straw walker. Elevator shaft speed should be between 110 and 115 RPM.



Rear access door to the bucket elevator.

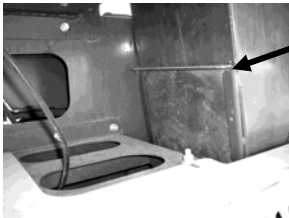

Front access door to the bucket elevator.

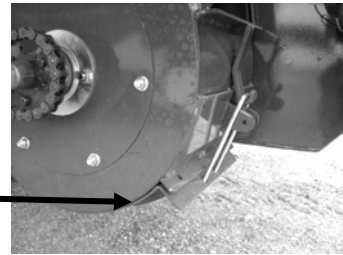

Bottom door for easy cleanout.

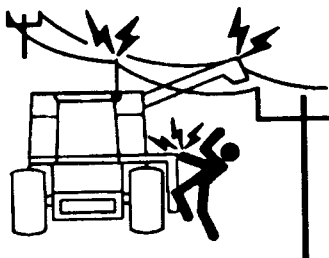

⚠ WARNING

Elevator Erected Height Is 14'10"

During transport, the elevator leg can be folded down at the hinge point to reduce overall height.

OBSERVE OVERHEAD OBSTACLES

Unloading System



Note! To prevent damage to the bin lifting system, the combine must be completely stopped before raising or lowering the bin. Never operate the tongue tilt while raising or lowering the bin.



Two bin cylinders lift the dump bin to unload the bean crop into awaiting truck.

A pressure relief valve is located on the down stroke of the bin rams. Keep this set to a minimum, 500 PSI or less.

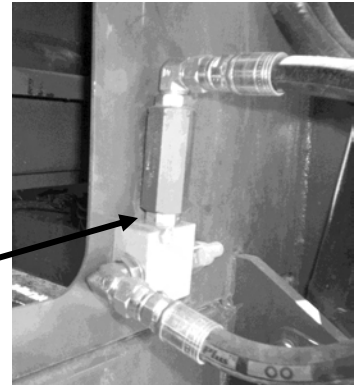

Always secure bin with mechanical locks.

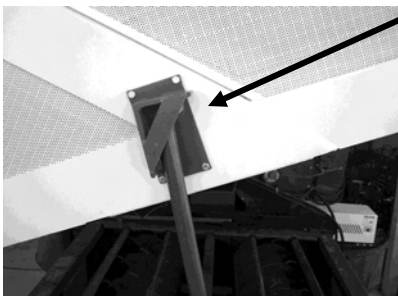

Safety feature The counter balance valves (one located on each dump bin cylinder) are hydraulic safety locks, to keep the bin from being lowered, as long as the tractor is not running.

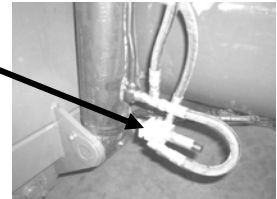

⚠ WARNING

With Dump Bin Raised Height Is 30'6"

OBSERVE OVERHEAD OBSTACLES

Straw Chopper

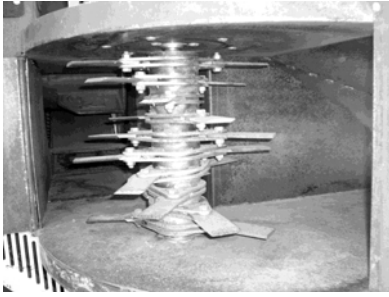

Each discharge on the Twin Master is equipped with a straw chopper. This helps to brake the straw into smaller pieces and move the material evenly out of the discharge.

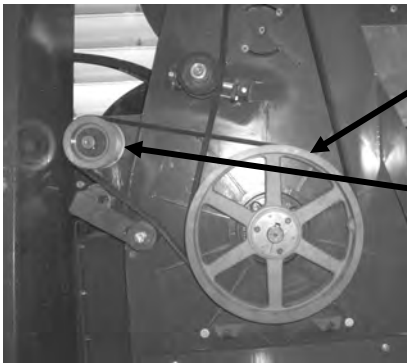

The straw choppers are belt driven from the end of the threshing cylinders.

Then to a intermediate jack shaft.

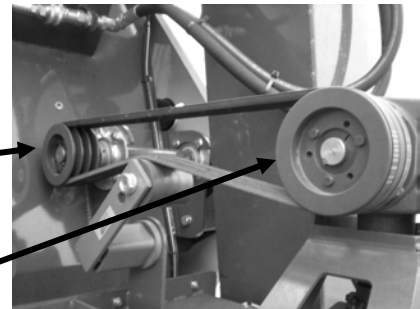

And finally to a 90° gear box.

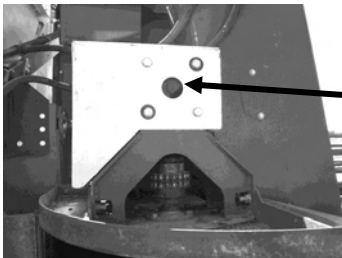

Oil level in the straw chopper gear box can be checked through this sight level gauge. Use Synthetic SAE 75W-90. Check daily.



A spreader with adjustable vanes helps evenly distribute the material.

Shaft Monitoring System

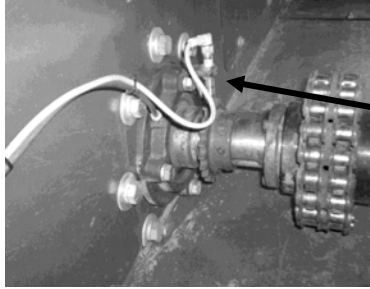

Threshing cylinder sensor

This sensor reads the RPM of the main threshing cylinder. It is located on the front shaft of the right hand cylinder.

All sensors should be no farther than 1/8" away from the object it detects.

Threshing cylinder RPM range 540 to 300.

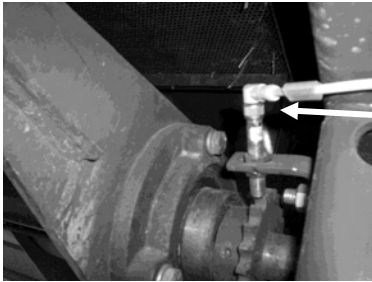

Shaker pan drive-shaft sensor

This sensor reads the RPM of the shaker drive shaft. It is located under shaker pan on the right side of the main shaker shaft.

The setting of this shaft should be approximately 340 RPM.

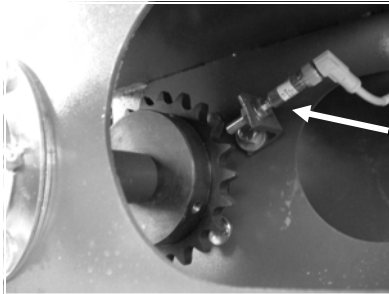

Bucket elevator speed

This sensor reads the RPM of the bucket elevator. It is located on the intermediate shaft between the bucket elevator and the straw walker shaft.

The setting of this shaft should be approximately 115 RPM.

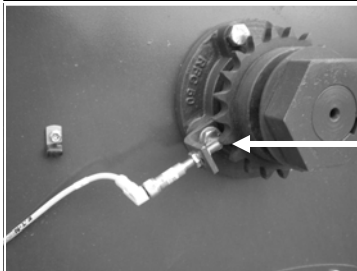

Transition auger sensor

This sensor located on the right hand end of the transition auger detects motion of the shaft. If the motion stops the alarm will sound.

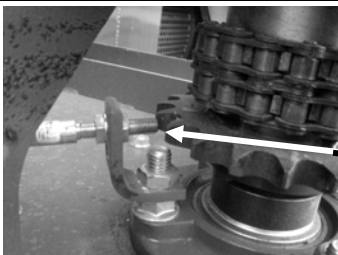

Straw chopper sensor

This sensor located on the top of each straw chopper and detects motion of the shaft. If the motion stops the alarm will sound.

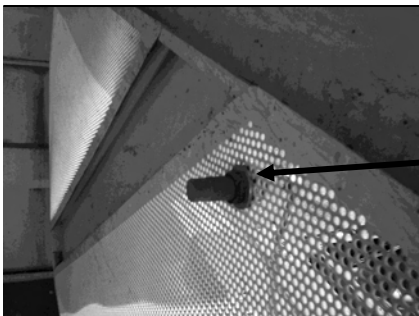

Bin full sensor

A bin level sensor is located on the front inside near the top of the bin. When the bin is full the switch is activated and the alarm will sound.

Appearance and location of sensors may vary.

Cleaning Out the Combine

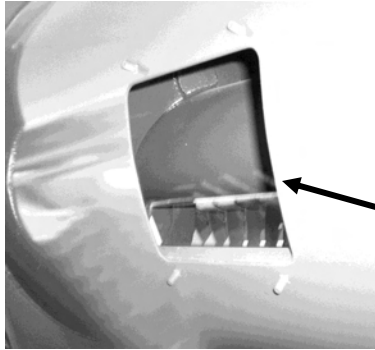

Cleaning the combine can be done with ease, in a short period of time.

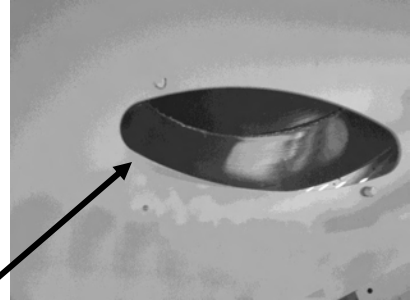

Remove the covers from the ends and rear of the transition auger and use air pressure for cleaning.



Operate combine shaker pan & bucket elevator long enough to visually see the area is clean. This final sieve area should mostly self clean by allowing the machine to run.

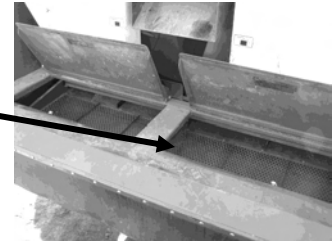

Inspect feeder house for crop residue, use air pressure or a broom to clean.



Raise dump bin to make sure it is clean, using a broom or air pressure. With dump bin in the raised position, a visual inspection can be made to the shaker pan area as well as the cylinder for final cleaning.

The shaker pan area should self clean by allowing the combine to run.

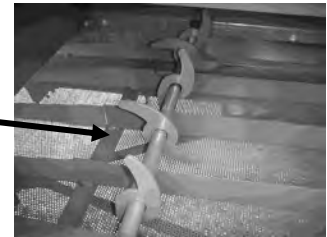

Open the hinged cover on the bottom each elevator leg. Operate machine long enough to make sure all buckets are clean.

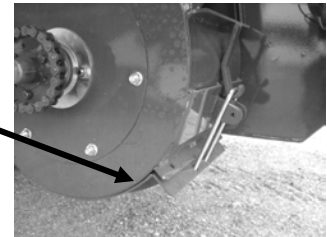

Once the combine is clean, replace all the covers and shields, lower the bin and you are ready for the next field.

Belt sizes and Configurations

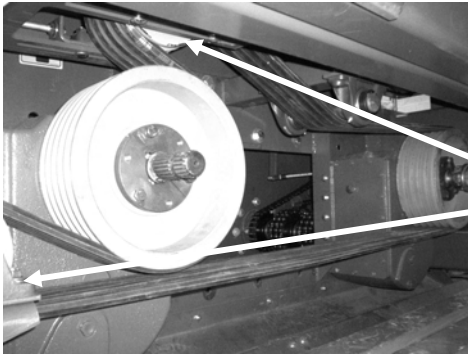

Keep All Shields In Place

2 speed transmission drive belt

Belt tensioners

Belt size CC-180 (5 required)



Pickup head drive belt

Belt tensioner

Belt size BB-85 (3 required)

Keep all belts tight

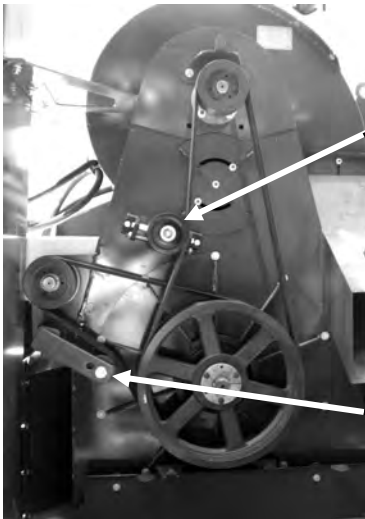

Vacuum fan drive (2 per combine)

Belt tensioner

Belt size B-103 (6 required)
540 / 390 Transmission

Belt size 3V1060 (2 banded belts required)
500 / 350 Transmission

Straw chopper drive (2 per combine)

Belt tensioner

Belt size B-82 (6 required) 540 / 390 Transmission

Belt size 3V850 (2 banded belts required) 500 / 350
Transmission

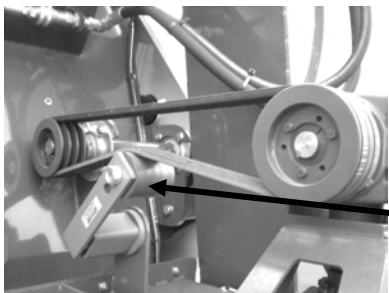

Straw chopper drive (2 per combine)

Belt size B-64 (6 required)

Belt tensioner

Chain sizes and Configurations

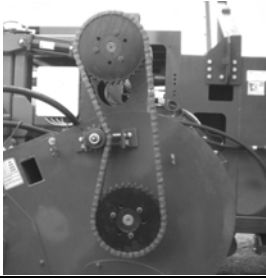

Keep All Shields In Place

Transition auger drive

Chain size—(RS 80-2)

Chain length—94 pins or 94 inches

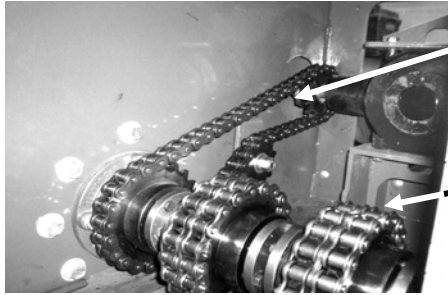

Transition auger gearbox drive chain

Chain size—(RS 80)

Chain length—58 pins or 58 inches

Threshing cylinder coupling chain (4 Required)

Chain size—(RS 80-2)

Chain length—21 pins or 21 inches

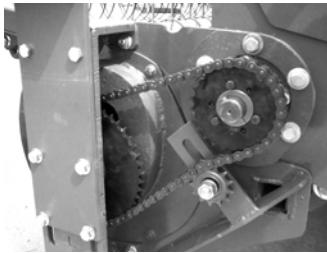

Pick up head drive chain

Chain size—(RS 50)

Chain length—74 pins or 46 1/4 inches

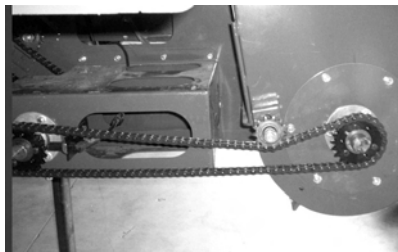

Bucket elevator to straw walker jack shaft drive chain

Chain size—(RS 50)

Chain length—111 pins or 69 3/8 inches

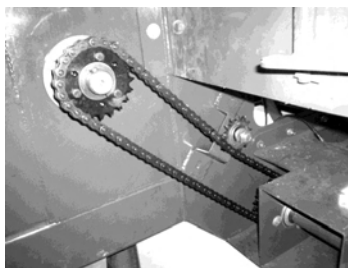

Straw walker drive chain

Chain size—(RS 50)

Chain length—82 pins or 51 1/4 inches

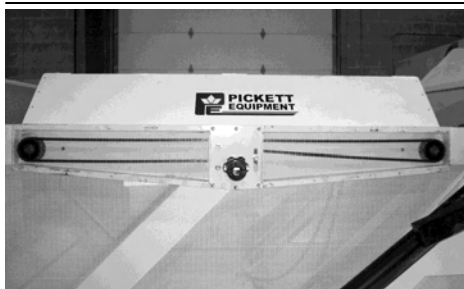

Leveling auger drive chain

Chain size—(RS 50)

Chain length—286 pins or 178 3/4 inches

Lubrication and Maintenance

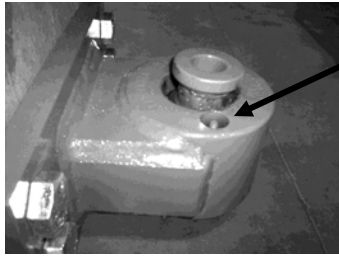

Dura-ball located on swing tongue.

8-10 hrs.

Swing tongue pivot pins
(2 places).

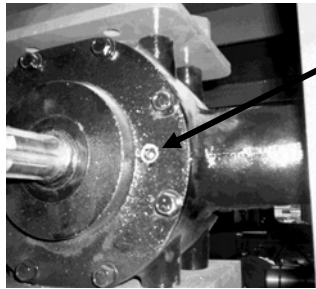
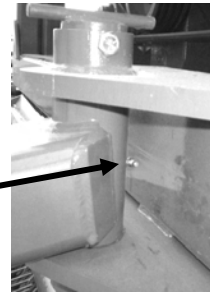

Transition auger gear box level plug.

Check Daily
Synthetic SAE 75W-90

Driveline telescoping members.
Drivelines without zerk need to
be taken apart and lubed.

8-10 hrs.

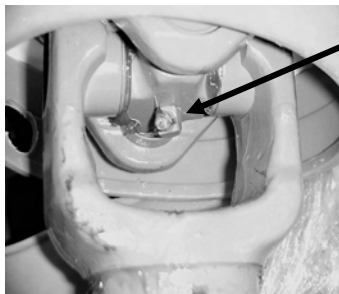
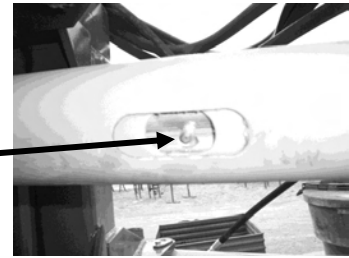

Lube all driveline cross joints.

8-10 hrs.

Driveline shields need to be
lubed through plastic nipple.

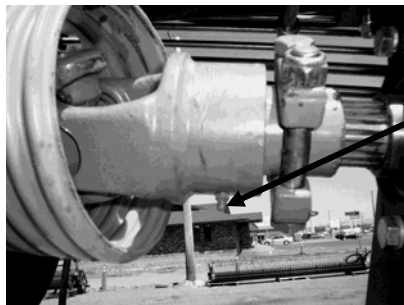
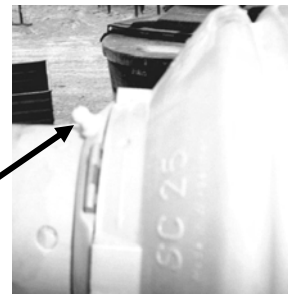

Overrunning clutch on the
tertiary driveline 8-10 hrs.

Radial pin clutch
Lube after clutch releases.

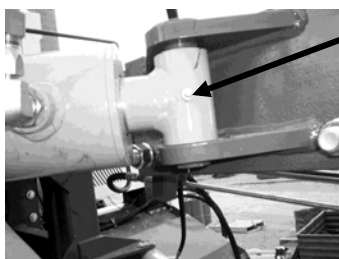
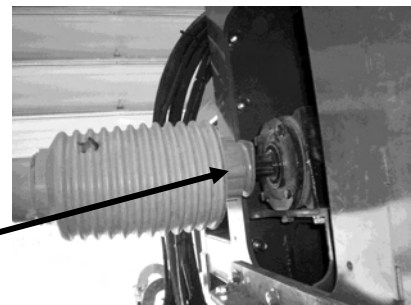

Swing tongue ram
(4 places).

Transmission drive belt idlers
(6 places).

8-10 hrs.

Front threshing cylinder bearings.

25-30 hrs.

1-2 pumps only.

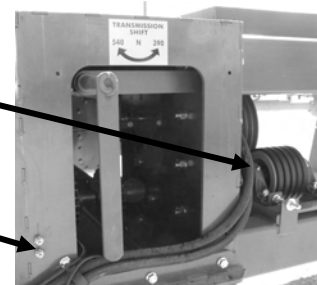

Lubrication and Maintenance

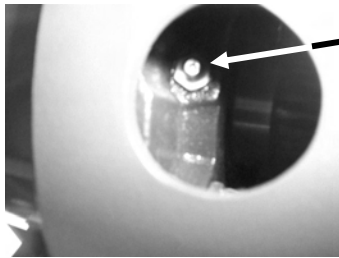

Stationary driveline bearing
(2 places).

25-30 hrs.

Threshing cylinder rear bearings
Vacuum fan rear bearings
(4 places).
1-2 pumps only.

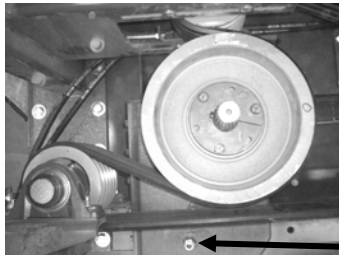
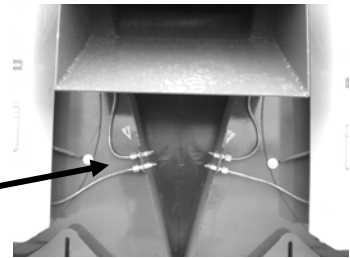

Straw chopper gear box sight level gauge (2 places).

Check daily
Synthetic SAE 75W-90

2 speed transmission sight level gauge (2 places).

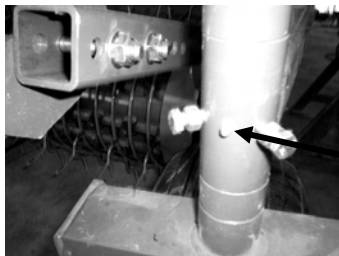
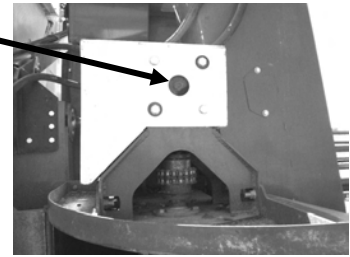

Main wheel hub & bearings. One lube site for each wheel. Lube every 40-50 hrs.

Front gauge wheels lube each wheel every 8-10 hrs.

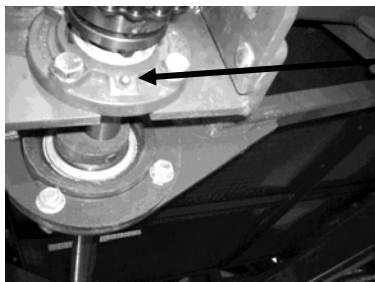
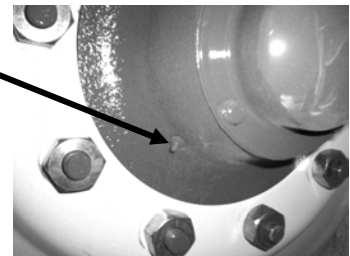

Shaker pan shaft and eccentric shaker frame bearings (7 places).

25-30 hrs.
1-2 pumps only.

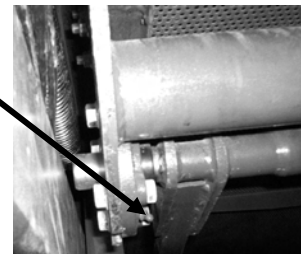

Check daily
SAE 80W-90

Top and bottom halves of the swivel gear box have separate oil level plugs. Level at the bottom of the tractor side plugs.

Lube center zerk 8-10 hrs.

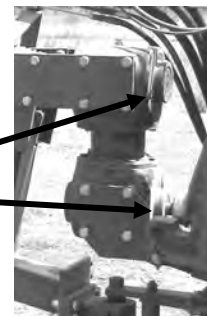

Lubrication and Maintenance

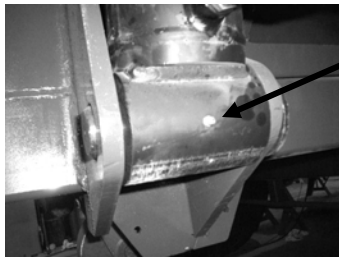

Dump bin ram lower pivot
(2 places).

8-10 hrs.

Dump bin ram upper pivot
(2 places).

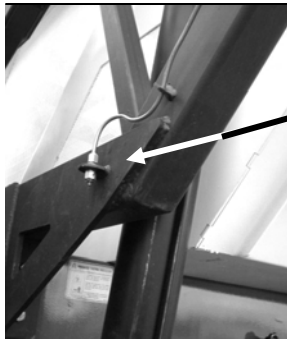
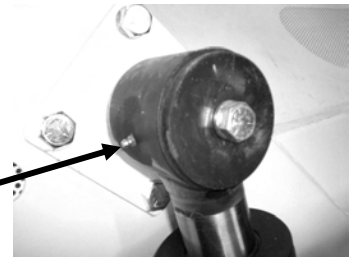

Dump bin pivot
(2 places).

8-10 hrs.

Front of vacuum fan
(2 places).

25-30 hrs.

1-2 pumps only.

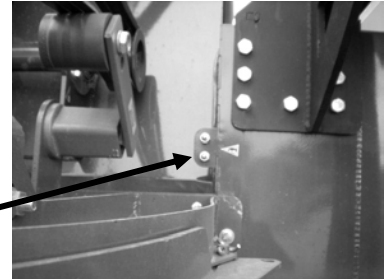

Transition auger drive idler.

8-10 hrs.

Vacuum fan drive idler
(2 places).



Tire Specifications



Tire size-30.5L—32
Maintain 24 PSI in the left side
And 40 PSI in the right side



Pickup head tire
Tire size-18 x 9.5—8
Maintain 24 PSI

Storage & Winterizing

- Clean combine of all crop residue.
- Empty all crop from bin.
- Lubricate all grease fittings.
- Pull all drivelines apart and clean and lube telescoping members. Lube all cross bearings and plastic guard tubes.
- Check tires for proper inflation.
- Fold elevator leg over, if necessary for storage.



TROUBLE SHOOTING - Problems (P) / Solutions (S)

P. Hydraulic oil is overheating.

S. Excessive oil flow. The oil to pickup head, feeder house, shaker table, bucket elevator, cross conveyor, and leveling augers in bin are operated in series by one remote. Do not use more oil than required. Open shaker table flow control on the motor to full ON (counter clockwise). Regulate the flow of hydraulic oil from the tractor until shaft speed on shaker is approximately 350 RPM then set the speed to 340 RPM using the flow control on the shaker motor. There will be plenty of oil to operate rest of machine.

S. Check hydraulic oil level in tractor. Check hydraulic filters on tractor. Check for blocked oil cooler on tractor.

P. Pickup head stops and will not turn.

S. Check all chains and sprockets for tightness and alignment.

S. Check touch screen monitor and make sure the pickup head speed control is turned up and on.

S. Check belts from star feeder to pickup head for tightness, if worn replace.

S. Check cam arms on pickup head for proper tracking in the cam.

S. Check the cam bearings for wear.

S. Check Fuses.

S. Check that 12 Volt power supply is properly connected to the tractor and has a good ground.

S. Check to see electrical receptacle for the solenoid on aluminum valve block is connected properly, clean and reconnect.

S. Check for any obstruction in star feeder or pickup head.

P. Shaker table not working properly.

S. Check all fasteners for tightness on eccentric shaker arm and bearing assembly.

S. Check shaker pan springs that support shaker table. Make sure they are not bent or broken and replace when necessary.

P. Picking up rock with pickup head.

S. Slow pickup head down to 1/2 of ground speed.

S. Operate pickup head teeth 1/2" to 2" above soil surface. Use adjustable gauge wheels to maintain proper height.

S. Operate entire combine level, an assist chain from the lower 3 point arms to the drawbar will help accomplish this.

P. Pickup head not picking up windrow.

S. Check for broken chain/hydraulic motor.

S. Replace broken teeth.

S. Lower pickup head until pickup head teeth are 1/2" to 1" above ground surface.

S. Check cam bearings and finger tube bolts.

P. Broken Teeth.

S. Running pickup head too low.

S. Check for damaged rotor rods rubbing fingers.

P. Transition auger plugging.

S. Slow down and reduce crop feeding into machine.

- S. Check for bent auger flighting or worn paddles.**
- P. Splits or cracks in beans.**
 - S. Slow down cylinder by reducing RPM on tractor or change speed at transmission to low gear. Remember when slowing down cylinder, vacuum will require adjustment accordingly.**
 - S. Inspect threshing pins and location make sure the pins are not too close to the concave. Pins are normally at the bottom of the pin pocket with a minimum of 1/2" to 3/4" clearance between the pin and the concave.**
 - S. Stop the combine abruptly while threshing. Remove inspection plates on the sides of the combine and inspect product on the shaker table for splits and damage and location of damage. This may not be the only place to look for damage. Bucket elevators, bucket elevator augers or shaker table may not be operating at the correct speed and causing the damage. Once the problem area has been found make proper adjustments accordingly to eliminate damage.**
- P. Production capacity loss.**
 - S. Threshing pins may be set to aggressively slowing the threshing process. Go back to start up setting.**
 - S. Check for bent auger flighting on main threshing cylinders. Check for bent auger flighting or worn paddles on the transition auger. Repair as needed.**
- P. Pickup head stalling.**
 - S. Tighten belts between the star feeder housing and the pickup head. Belt dressing may be used to reduce slipping.**
 - S. Check all fasteners throughout pickup head and make sure they are tight and positioned correctly.**
 - S. Check drive chain and sprockets for proper tension and alignment.**
- P. Dirt in beans.**
 - S. Slow pickup head down, if the pickup head speed is too fast dirt is not allowed time to fall to the ground.**
 - S. Pickup head operating too low, with teeth digging in the dirt. Lower gauge wheels to bring teeth up.**
 - S. Adjust cutting & windrowing system to eliminate dirt before it gets to the combine.**
 - S. Inspect vacuum fan. Listen, and feel combine for unusual vibration. Clean fan blades when buildup occurs.**
 - S. If dirt is from small dirt clods use a smaller final screen. Make sure bumper bar is adjusted correctly.**
- P. Monitor not functioning properly.**
 - S. Check all electrical connections and wiring. Check 12-Volt power source. Check entire system for damage.**
 - S. Check Fuses.**
 - S. Make sure sensors are the proper distance from the sprockets.**
- P. Transition auger plugged.**
 - S. The right side of the auger will accept a tool that is provided with the combine to reverse the auger, aiding in the unplugging process.**
 - S. Check for mechanical failures such as a seized bearing, misaligned sprockets and chain or faulty radial pin clutch.**

- S. Check for worn auger flighting and paddles.**
- P. Trash in bin with beans.**
 - S. Adjust vacuum.**
 - S. Check condition of fan and shroud.**
 - S. Check belt tension on the vacuum fan.**
 - S. Check cylinder pin setting.**
 - S. Check final screen size.**
- P. Plugged elevator.**
 - S. Conditions are too wet.**
 - S. Bearing seized or worn out.**
 - S. Bucket elevator chain loose and lodged or caught.**
- P. Leaving beans on ground from windrow.**
 - S. Pickup head operating too high off the ground. (If leaving whole plants).**
 - S. Pickup head operating at too fast of RPM.**
 - S. Pickup head operating too low, finger is bending in the dirt then hitting the crop with enough force to thresh the plant on the ground.**
 - S. Tractor tires running over the windrow.**
- P. Leaving beans on ground behind the combine mostly cracked.**
 - S. Too much vacuum suction, adjust suction.**
 - S. Shaker pan speed too fast causing crop to bounce.**
- P. Leaving beans on ground from final screen.**
 - S. Final screen out of adjustment.**
 - S. Final screen too small for seed size.**
 - S. Holes in final screen plugged with debris.**
 - S. Damage to shaker pan or belting seal around the shaker pan.**
 - S. Rate of travel too fast for combine capacity.**
- P. Leaving beans on ground behind the combine unthreshed and mixed with straw.**
 - S. Cylinder pin setting may need to be more aggressive.**
 - S. Cylinder RPM may need to be changed to a faster speed.**
 - S. Threshing pins may be worn out, keep threshing pins in good condition.**
- P. Leaving beans on ground behind the combine threshed but mixed with straw.**
 - S. Cylinder pin setting may need to be more aggressive.**
 - S. Set a pin near the rear of the cylinder to an extreme hard thresh or 60° forward setting, then the next pin to the extreme easy thresh or 60° rearward setting. Repeat this pattern two to four times. This will tear the foliage apart and let the crop find the holes in the concave.**
 - S. If holes in concave are covered with a mat of grass or foliage set a few pins near the rear of the concave close to the concave and pointing to the rear of the combine to help sweep the material off of the concave.**
 - S. Cylinder RPM may need to be changed to a faster speed.**
 - S. Replacing two pins with knives (usually pins # 1 and # 4) will help break the foliage into smaller pieces and allow the crop to more easily find the concave holes. Remove the threshing pin and place the knife on the same side of the flighting as the pin was. Use a 9/16" spacer so the knife cuts straight through the material.**

Average Fan and Chopper Speeds

With 540 / 390 Transmission

Transmission in high gear and large (5.4) sheave on fan – chopper drive small to large (4.8 to 5.4)

<u>Tractor</u> <u>Speed</u>	<u>PTO</u> <u>Speed</u>	<u>Cylinder</u> <u>Speed</u>	<u>Fan</u> <u>Speed</u>	<u>Chopper</u> <u>Speed</u>
2100	1000	541	1842	1842
1950	929	502	1710	1710
1800	857	463	1579	1579

Transmission in low gear and small (4.8) sheave on fan– chopper drive large to small (5.4 to 4.8)

<u>Tractor</u> <u>Speed</u>	<u>PTO</u> <u>Speed</u>	<u>Cylinder</u> <u>Speed</u>	<u>Fan</u> <u>Speed</u>	<u>Chopper</u> <u>Speed</u>
2100	1000	392	1503	1691
1950	929	364	1396	1570
1800	857	336	1289	1450

With 500 / 350 Transmission

Transmission in high gear and large (5.3) sheave on fan – chopper drive small to large (4.8 to 5.4)

<u>Tractor</u> <u>Speed</u>	<u>PTO</u> <u>Speed</u>	<u>Cylinder</u> <u>Speed</u>	<u>Fan</u> <u>Speed</u>	<u>Chopper</u> <u>Speed</u>
2100	1000	500	1805	1893
1950	929	464	1676	1757
1800	857	429	1547	1622

Transmission in low gear and small (4.12) sheave on fan – chopper drive large to small (5.4 to 4.8)

<u>Tractor</u> <u>Speed</u>	<u>PTO</u> <u>Speed</u>	<u>Cylinder</u> <u>Speed</u>	<u>Fan</u> <u>Speed</u>	<u>Chopper</u> <u>Speed</u>
2100	1000	347	1617	1663
1950	929	322	1501	1545
1800	857	298	1386	1426

Specifications

Total working width	20' 8"
Total height	14' 10"
Total length	35' 2"
Weight	24,500 lbs.
Bin capacity	18,500 lbs. approximately
Usable pickup head width	174"
Dump height	13'
Tire size	30.5L – 32 16 ply
Tractor requirements	200 PTO horse power – minimum 240 PTO horse power – maximum 4 hydraulic remotes – 18 GPM 1 3/4" 20 spline 1000 RPM PTO

Machine Identification

For parts and service please have the following information:

- Model Year
- Serial Number

Refer to machine ID tag



Pickett Equipment

976 East Main Street * Phone: 208-678-0855 * www.pickettequipment.com
Burley, Idaho 83318 * Fax: 208-678-1404 * pickett@rvmi.com