



PICKETT EQUIPMENT

Operator's Manual



Double Master Plus Dry Edible Bean Combine

Central Flow -- Low Impact



Pickett Equipment

976 East Main Street * Phone: 208-678-0855 * www.pickettequipment.com
Burley, Idaho 83318 * Fax: 208-678-1404 * pickett@rvmi.com

Double Master Plus Combine Table of Contents

Table of Contents	I
Congratulations	1
Pickett Equipment Warranty.....	2
Disclaimers	3
Pre-delivery Checklist	4-7
Delivery Checklist.....	8
After Sale Checklist.....	9
Safety Information	10-13
Introduction.....	14
General Operating Instructions.....	15-17
Shaft Monitor System.....	18-21
Lights and Signals.....	22
Setting up the Tractor	23-24
Complete Drive Train	25-26
Feeder House.....	27
Concave Separator and Threshing Cylinder	28-29
Combine Cylinder Adjustment	30
Combine Cylinder Startup Settings	31
Combine Shaker-Separator	32
Final Sieve.....	33
Vacuum Cleaning System.....	34
Bucket Elevator	35
Unloading System	36
Shaft Monitoring System	37
Cleaning Out the Combine.....	38
Lubrication and Maintenance	39-40
Transporting	41
Tire Specifications.....	42
Storage and Winterizing.....	42
Trouble Shooting.....	43-46
Average Threshing Cylinder and Fan Speeds	47
Specifications	48
Hydraulic Hose Specifications	49



*Manufacturers of
the Most Innovative
Bean Equipment*

Congratulations on the purchase of your new Pickett Double Master Plus Edible Bean Combine. We welcome you to an ever-growing family of farmers using the Pickett system to harvest their bean crops, as well as peas and lentils. Thanks to your patronage, and the patronage of others like you, Pickett Equipment has become recognized as the most progressive and innovative bean harvesting equipment manufacturer in the industry.

We credit the customer with our success. After all, it is the farmer's input and suggestions over the years that has molded and refined the Pickett Equipment designs. We will continue to value the knowledge that you contribute, and seek to be responsive to your needs.

We encourage you to read the Operators Manual thoroughly and carefully to ensure satisfactory and trouble-free operation. Failure to do so could result in equipment failure or personal injury. Again, we thank you for choosing Pickett Equipment.

Sincerely,

PICKETT EQUIPMENT

Neil Harper, CPA
President/CEO

PICKETT FARM EQUIPMENT WARRANTY

Pickett Equipment warrants to the original purchaser of each item of new Pickett Farm Equipment that the product be free from defects in material and workmanship under normal use and service. If such equipment is found to be defective within one season or 350 acres, whichever shall occur first, the obligation of **PICKETT EQUIPMENT** under this warranty is limited to the repairing or replacing of (exclusive of the cost of labor and transportation), any equipment or parts, in the judgment of **PICKETT EQUIPMENT** to be defective in material or workmanship.

All equipment or parts claimed to be defective in material or workmanship must be made available for inspection at the place of business of a dealer authorized to handle the equipment covered by this warranty, or, upon request by **PICKETT EQUIPMENT**, shipped to the **PICKETT EQUIPMENT** factory in Burley, Idaho. **PICKETT EQUIPMENT shall have no obligation to bear the cost of labor or transportation in connection with replacement or repair of any such defective parts.** **PICKETT EQUIPMENT** will pay internal shop rates on the modification or repair of defective parts in the setup procedure.

This warranty covers only defects in material and workmanship. It does not cover depreciation or damage caused by normal wear, accident, improper assembly, improper adjustments, improper maintenance including lack of proper lubrication, or improper use. Therefore, **PICKETT EQUIPMENT** liability under this warranty shall not be effective or actionable unless the equipment is assembled, maintained and operated in accordance with the Operating instructions accompanying the equipment. **PICKETT EQUIPMENT** shall have no liability if the equipment has been altered or reworked without the written authorization of **PICKETT EQUIPMENT**.

Damages resulting from rocky conditions are not covered by this warranty.

PICKETT EQUIPMENT does not warrant commercial components not manufactured by **PICKETT EQUIPMENT**. But, if new, these components may be warranted by the manufacturer thereof.

The only remedies any purchaser has in connection with the breach or performance of any warranty of Pickett Farm Equipment are those set forth in this warranty. In no event shall **PICKETT EQUIPMENT** be liable for incidental or consequential damages or injuries including, but not limited to, loss of crops, loss of profits, rental of substitute equipment or other commercial loss.

This warranty is expressly in lieu of any other express or implied warranties including any implied warranty of merchantability or fitness for particular purpose and of any other obligation on the part of **PICKETT EQUIPMENT**.

PICKETT EQUIPMENT makes no warranties, representations or promises, express or implied as to the quality or performance of Pickett Farm Equipment other than those set forth in this warranty. Neither the dealer nor any other person has any authority to make any representations, warranties or promises on behalf of **PICKETT EQUIPMENT** or to modify the item manufactured or sold by **PICKETT EQUIPMENT** or any other time unless he delivers to the purchaser a separate written warranty specifically warranting the same, in which case **PICKETT EQUIPMENT** shall have no obligation thereunder.

PICKETT EQUIPMENT parts, which are furnished under this warranty and properly installed, shall be warranted to the same extent as the original parts under this warranty if, and only if, such parts are found to be defective within the original warranty period covering the original equipment.

No warranty request will be considered, and **PICKETT EQUIPMENT** will have no liability under this warranty, unless the Pickett Equipment Delivery Checklist and Warranty Registration Forms have been properly filled out and returned to **PICKETT EQUIPMENT**, at Burley, ID. **PICKETT EQUIPMENT** warranty forms must be filled out with every claim. Claims must be submitted by the dealer to Pickett Equipment's home office. All warranty work must be completed within 30 days of failure. No claim will be accepted for warranties that exceed this 30 day period.

Warranty Disclaimers

The following conditions will void the warranty for the Double Master Plus Combine

Removing *safety* shields, guards or safety instructional stickers

Using tire sizes other than those standard to Pickett Equipment

Not maintaining or operating equipment according to Operator's Manual

Operating equipment in a malicious or reckless manner

Using replacement parts not of Pickett Equipment origin

Making modifications to the equipment other than those recommended by Pickett Equipment

Changing combine wheels around for a wider profile

Not signing and sending in the warranty registration to Pickett Equipment within 30 days of delivery

Pickett Equipment will strive to make product improvements every year, but we cannot be responsible for making updates or additions to equipment previously sold.



DOUBLE MASTER PLUS

PREDELIVERY INSPECTION AND SET-UP And ANNUAL MAINTENANCE INSPECTION CHECKLIST

Note: Items highlighted with *asterisks represents new combine predelivery inspection and set-up. This service should be performed by either Pickett service personnel or authorized Pickett dealer service personnel. Items without *asterisks are a guide to routine annual maintenance that could be done on the farm or by any authorized Pickett dealer. Items with **asterisks apply to both.

1.	*Remove all uninstalled parts from the bin.
2.	*Inventory driveline system components (Walterscheid).
3.	*Assemble pickup head gauge wheels, left and right. Mount to pickup head.
4.	**Check sprockets and bearings on main cylinder shaft to 90° gearbox. Ensure alignment, tighten and secure. Check chain tension. Inspect 90° gearbox oil level.
5.	**Inspect connections of radial pin clutch to gearbox and drive shaft to transition auger.
6.	**Inspect 45mm bearing next to transition auger upper drive pulley.
7.	**Check upper and lower transition auger pulleys or sprockets for alignment. Check idler bearings. Check idler alignment. Check tension.
8.	**Inspect bearings on both ends of transition auger.
9.	**Inspect belt and belt tension from the transition auger to the star feeder drive pulleys.
10.	**Lubricate pickup head drive chain and adjust chain tension. Check sprockets for alignment and tightness.
11.	**Inspect pickup head assembly, cam bearings, cam tracks, rubber pickup teeth and finger rod connections.
12.	**Inspect star feeder. Rotate by hand listening for misalignment of stripper bars.
13.	Inspect bottom of star feeder housing for damage. Repair as needed.
14.	Inspect transition auger flighting for wear. Auger flighting edge may require hard surfacing or weld on wear strips. Start in the auger center and move outward as needed.
15.	*Install pickup head drive motor and couple to shaft with split coupler. Check for alignment and tighten socket head bolts on coupler.
16.	*Assemble ladders and handrails to platform.
17.	*Check transition auger motion sensor for proper placement. Clearance for the sensor should be 1/8" (3 mm).
18.	**Check pickup head and roller sprockets for alignment and chain tension. Lubricate as needed.

19.	Check pickup head pivot points for wear on both sides of the machine. Repair as needed.
20.	**Check pickup head gauge wheel tire pressure. Recommended pressure is 24 PSI (165 kPa). Inspect gauge wheel bearings. Lubricate or replace as needed.
21.	**Check all hydraulic valves, lines, and fittings for leaks.
22.	*Check all hydraulic motor coupler connections on the star feeder, shaker motor, and leveling auger motor.
23.	**Inspect all hydraulic cylinders and dump bin pins. Lubricate as needed.
24.	**Check all electrical cords to lights and monitor system. Ensure they are clean and securely fastened to framework.
25.	**Inspect main tire pressure. Recommended pressure is 20 PSI (140 kPa). Ensure that all main wheel lug nuts are tightened. Inspect main hubs. Inspect hub bearings by removing dust cover. Lubricate bearing as needed. Inspect hub bearing preload (with weight off of tire) by tightening castle nut firmly and then by backing off tension by approximately 1/4 turn or to next notch on castle nut. Replace dust cover repeat on other side.
26.	**Inspect shaker table leaf springs. Access through side cover. Replace any damaged leaf springs. Ensure table is level in relation to main frame. Tighten securely to mounts using grade 5 bolts and heavy-duty flat washers. Tighten with double nut or whiz-type nut.
27.	**Check shaker table wishbone connection to shaker table. Ensure that fasteners are secure. Lubricate wishbone anchor points. Inspect eccentric bearing and grease as needed. Inspect eccentric drive shaft pillow bearings and lubricate as needed.
28.	**Remove shaker table and elevator leg sprocket shields. Inspect shaker table and straw walker belts, bearings, and pulleys for alignment and lubrication.
29.	**Remove left and right shaker table inspection shields. Check straw walker tines for even placement between shaker table dividers.
30.	Check shaker table double bearings. Bearings are located in the bearing housing behind the shaker table motor.
31.	**Inspect sprocket and chain alignment from shaker table drive shaft to elevator leg. Lube chain and bearings on both sides of elevator leg. Check outside sprockets for alignment and lube chain. Replace all shields.
32.	*Lift upper elevator leg into place and secure with provided fasteners.
33.	*Connect bucket elevator chain. Connection can be done through the leg cleanout cover at the bottom of the elevator leg.
34.	**Adjust bucket chain tension. Tensioners are located on each side of upper elevator leg. Ensure that shaft placement is perpendicular to the bucket chain. 1/2" to 3/4" (12.5 to 19 mm) deflection in chain is needed.
35.	**Inspect bearings on both ends of the elevator cross auger.
36.	*Inspect final shaker screen. Ensure proper screen operating position, approximately 1/4" (6 mm) higher in rear. Ensure tilt-adjustment bolts are securely fastened.

37.	Check the condition and placement of the bumper bar. The proper placement of the bumper bar is to have the center of the bar slightly above the finial sieve.
38.	*Inspect vacuum setting. Recommended initial setting of vacuum adjustment plate is at level 4.
39.	Inspect turbine blades and vacuum shroud. Open rear pulley shield to expose vacuum inspection plate located below the upper drive pulley. Loosen nuts and drop plate. Use a flashlight for inspection of turbine blades and vacuum shroud. It is important to keep turbine fan blades free of buildup to ensure fan balance. Inspect shroud and turbine fan for normal wear. Clean and replace as needed.
40.	Inspect vacuum drive belt for alignment. Inspect belt idler bearings. For bearing replacement, use high speed sealed bearings.
41.	*Inspect position and clearance of threshing cylinder speed sensor. Correct clearance in 1/8" (3 mm).
42.	*Inspect rubber belting from elevator leg transition to bin chute.
43.	Inspect bin leveling auger. Inspect the hydraulic motor coupler and both auger shaft bearings.
44.	*Install dump bin extension and elevator leg bin chute. Check bin chute for proper alignment. Clean bin of any foreign material.
45.	*For DMP straight pull behind models. Install adjustable pull tongue. Ensure that pull tongue placement allows for level operation. Install jack. Remove shipping stand.
46.	*For DMP straight pull behind models. Hook up tractor to combine. Recommended hitch pin is 1 1/8"x 7" grade 8 bolt with two heavy-duty flat washers and 2 nuts.
47.	*For DMP SP and SP2 models. Hook up tractor to the combine according to instructions found later in this manual.
48.	*Install primary driveline always connect shield chain to a secure location.
49.	**Remove cut-out clutch guard and inspect the cut-out clutch and connection to intermediate shaft. Recommended clamping cone bolt torque is 75 foot pounds (102 newton meters). Grease bearing and replace cut-out clutch guard. Attach shield chain to a secure location.
50.	*Install and test monitor system.
51.	Hook up hydraulic lines to tractor for initial startup and testing. IMPORTANT! Inspect distance from elevator leg to bin chute prior to raising bin. Ensure that a safe margin is maintained while lifting. Check for hydraulic leaks.
52.	**Inspect threshing pin placement and tightness. Rotate threshing cylinder by hand to observe pin clearance to concave bars. Recommended minimum clearance is 1/2" to 3/4" (12.5 to 19 mm). In normal conditions operate with pin at the bottom of the pin pocket.
53.	**Inspect bin to concave seal. Adjust concave channel seals as needed.
54.	*Test pickup head lift and drop. Adjust tractor hydraulic flow to regulate pickup head lift and drop speed. Set pickup head teeth ground clearance to 1" (25.4 mm) by adjusting gauge wheels.

55.	*Test hydraulic motor circuit. Motors operate in following series: 1) Pickup head, 2) Shaker Table, 3) Leveling Auger. Check and remedy all hydraulic leaks. Operate shaker table at approximately 320-330 Rpm. Using the touch screen monitor turn pickup head on and off to ensure it is operational.
56.	**Inspect 2 speed transmission, check oil level, and coupling sprockets and chains.
57.	**For DMP SP and SP2 models. Inspect swivel gear box mounts for loose bolts. Check oil level – top & bottom sections have separate oil levels.
58.	**Test all drive train components by slowly engaging the PTO. As the PTO is engaged the threshing cylinder and vacuum fan can be tested. Listen, feel and inspect combine for any abnormal sounds or vibrations. Adjust and remedy as needed.
59.	**Inspect the straw chopper, then test run the straw chopper. Listen, feel and inspect chopper for any abnormal sounds or vibrations Ensure that chopper monitor sensing system is working properly.

Combine Serial #

Customer or Dealer

Service Department or Technician

DELIVERY CHECKLIST

Review the Operators Manual with the customer. Explain the following:

- Pickett Equipment Warranty.
- Warranty disclaimers.
- Safe and correct operation and service.
- Tractor wheel adjustment, to ensure that the tractor does not run on the windrow (See your tractor manual).
- Daily and periodic inspections.
- Correct machine servicing and maintenance.
- Explain wear items, including fan and shroud maintenance.
- Combine and tractor tire pressure.
- Correct machine transport procedure.
- Walterschied safety and service manual in addition to driveline operating instructions.
- Optional attachments that are available for special crop and operating conditions.
- Operator's manual and parts listings.
- Warranty registration including registration of unit serial number.
- Sending in Warranty Registration to Pickett Equipment.

Date Checked

Signature

AFTER SALE CHECKLIST

Dealer / Customer

It is suggested that the following items be completed and then checked sometime prior to operation.

- Inspect for loose or missing bolts.
- Run the machine to see if it is functioning properly.
- Ensure that all safety shields and all safety stickers are in place.
- Verify that all chains and belts are aligned and tightened correctly.
- Check to ensure that decals are intact and legible.
- Inspect for broken or damaged parts.
- Review the entire Operator's Manual with the customer and stress the importance of correct and regular lubrication as well as safety precautions.

Date Checked

Signature



SAFETY SIGN

This is a safety-alert symbol. When you see this symbol on your machine or in this manual, be alert to the potential for personal injury.

Follow recommended precautions and safe operating practices.



DANGER

- **Observe overhead obstacles when raising dump bin**

Peligro

Antes de accionar la tolva de descara fijense que no haya obstaculos sobre esta



DANGER

- **ROTATING DRIVELINE KEEP AWAY**
- Contact can cause death
- **Do not operate without--**
- All driveline guards and equipment shields in place
- Drivelines securely attached at both ends
- Driveline guards that operate properly













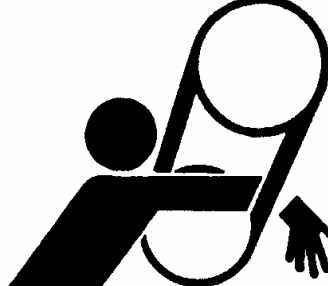

Warning

CRUSHING HAZARD

- To prevent serious injury or death
- **Do not work beneath the bin while in the raised position, while tractor is running or counter balance valves are missing.**
- Tongue stand must be in place while connecting or disconnecting from the tractor.

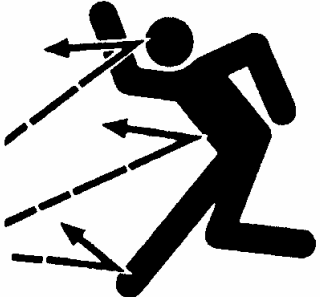
	 <h2 style="text-align: center;">Caution</h2> <ul style="list-style-type: none"> • High pressure oil leaks can penetrate the skin causing serious injury & gangrene. If this injury occurs consult a physician immediately. • <u>Do not</u> use fingers or hands to check for hydraulic oil leaks. • Release pressure before loosening hose fittings, always work with cool hydraulic oil.
	 <h2 style="text-align: center;">Peligro</h2> <ul style="list-style-type: none"> • <u>Conserve alejado de el cardan en operacion</u> • <u>Alejese!</u> El contacto con este puede causar injuria o muerte. No opera sin! Que el cardan se proteccion del cardan y laminas de proteccion se deben de mantener en su lugar. Asegure que el cardan esta bien instalado a el tractor y combinada. Piezas de seguridad del cardan giran entre ellos mismos. Asegurarse que la proteccion de seguridad del cardan opera en su forma debida.
	 <h2 style="text-align: center;">ADVERTENCIA</h2> <ul style="list-style-type: none"> • <u>PELIGRO de Astamiento</u> • Para prevenir sérias lesiones o muerte. No trabaje bajo la tolva cuando este en posicion de descarga a menos que se cilindro en su posicion correcta. • El estante o soporte del jalon de la cosechadora se debe de ajustar a la altura requerida antes de conectarse o desconectarse al tractor.
	 <h2 style="text-align: center;">Precaucion</h2> <ul style="list-style-type: none"> • Fugas de aceite de alta presion al tocar la piel causa sérias lesiones o cangrena. • Sérias lesiones o cangrena. Si esta lesion ocurre, consulte a su medico inmediatamente. • No use dedos o manos para revisar por posibles fugas de aceite hidraulico. Elimine o reduzca presion en el sistema hidraulica antes de aflojar las conexiones de mangueras y cuando el aceite este frio.

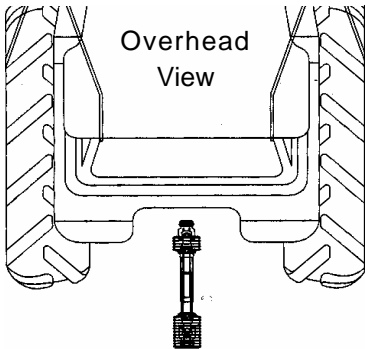
	<p> Warning</p> <p><u>Crushing hazard</u></p> <p>Do not place hands, fingers, or arms inside separating area while combine is in operation. Hands and fingers may become subject to serious injury.</p>
	<p> DANGER</p> <p><u>Shield Missing Do Not Operate Combine</u></p> <p><u>No Opere la combinada sin sus laminas de proteccion.</u></p> <p><u>Keep all shields in place</u></p>
	<p> DANGER</p> <p><u>Combine must be shut off to make changes in cylinder</u></p> <p><u>Peligro</u></p> <p>La combinada debe de estar apagada al hacer cambios al cilindro de trilla</p>
	<p> DANGER</p> <p><u>Combine must be shut off to make belt adjustments</u></p> <p><u>Peligro</u></p> <p>La combinada debe de estar apagada al hacer ajustes a bandas o correas</p>

	<p> DANGER</p> <p><u>Riding equipment may result in serious injuries</u></p> <p><u>Peligro</u></p> <p>Subiendose a maquinaria en operacion puede causar sérias lesions</p>
	<p> Caution</p> <p><u>Beware of flying objects from the rear of combine</u></p> <p><u>Precaucion</u></p> <p>Tenga precaucion con los objetos saliendo de la parte trasera de la combinada</p>
 <p>Overhead View</p>	<p> Important</p> <ul style="list-style-type: none"> • Tight turns may cause driveline damage <p><u>Importante</u></p> <ul style="list-style-type: none"> • Vueitas extremas del tractor puede causar danos a el cardan
<ul style="list-style-type: none"> • <u>Refer to owners manual for all lubrication points</u> Dese referencia a el manual de operacion para puntos de <u>lubricacion</u> 	
<p><u>Important</u> <u>Lubrication</u> <u>site</u></p>	<p><u>Importante</u> <u>Sitio de Lubri-</u> <u>cacion</u></p>

Introduction

It is important, and informative, for the operator to take a few minutes to read and become familiar with this operators manual. It contains the necessary information to safely and effectively operate this combine, along with the adjustments and settings for varying conditions. This manual should become a permanent part of your machine and kept within reach, should question arise.

**Left hand
side of
combine**



**Right hand
side of
combine**

Rear view



Right front view

General Operation and Startup Instructions

The following information is provided to assist in the set-up of your Double Master Plus Combine. Also described are the proper functions and maintenance guidelines

1. Inspect all electrical lines and components. Make sure they are fastened securely and are free from any damage. Plug the Touch Screen Monitor and the AgCam Monitor into tractor's 12-Volt power source. (Note: 12-Volt power is converted to 24-Volt to operate the Touch Screen Monitor and PLC (programmable logic controller) while output to tongue tilt valve and pickup head speed control valve remains 12-Volt).
2. Check all hydraulic connections and fittings. Check for leaks and make sure all hoses are positioned correctly and free from damage.
3. Check all belts, chains, pulleys, and sprockets for alignment and for tightness.
4. Grease bearings that require grease (do not over grease). Most bearings only require minimum grease. Lubrication locations and amounts are located in the Lubrication and Maintenance section of this manual.
5. Inspect primary, secondary and tertiary drivelines for lubrication and make sure they are securely fastened especially the clamping cone on the Secondary Driveline (primary driveline on the straight pull model). Torque cut-out clutch side clamping cone bolt to 75-ft. lbs. (102 Nm). Make sure all setscrews and bolts are securely fastened. Driveline plastic guards need to be well greased and have shield chains securely attached.
6. Inspect pickup head for any loose bolts or broken parts. Inspect gauge wheel height to ensure pickup head is operating level and the teeth are working approximately 3/4" to 1 1/2" (19 to 38mm) above the soil surface.
7. Inspect feeder house star tines and scraper plates for alignment and tightness.
8. Inspect the combine from front to back while hooked to the tractor to make sure it will operate level. Use adjustable tongue height on combine tongue and the tractors draw bar adjustments to achieve this task. (Refer to setting up tractor page.)
9. The swivel gear box allows the tractor to be operated to the side of the windrow (SP & SP2 models). Care must be used when setting up the gear box stabilizer assembly. It must keep the lower part of the swivel gear box aligned with the tractor without binding.
10. The Double Master Plus requires 3 or 4 hydraulic outlets on the tractor (depending on model). The # 1 remote controls the raising and lowering of the pickup head. Regulate the flow of oil from the tractor so pickup head lifts smoothly and slowly. The # 2 remote should operate the pickup head, feeder house, shaker table, bucket elevator and leveling auger in the bin. To adjust hydraulic flow to this series of hydraulics, turn the pickup head on/off switch to ON and set the speed control at midway. Turn the shaker table flow control knob counter clockwise (Located on the shaker table hydraulic motor on the right side of the combine) to Full on (counter clockwise). Turn the hydraulic flow of your tractor down to a low flow rate. Using the combine monitor system RPM read out adjust the tractor's flow control until the shaker pan shaft speed is 340 RPM. Then using the flow

control located on the shaker motor to adjust the speed to 330 RPM, this will also operate the bucket elevator at 110 RPM. This should provide plenty of oil for the other operations without having more oil flow through the system than required (excessive flow causes excessive heat). Set the pickup head speed control where the pickup head speed does not exceed 1/2 operational ground speed, approximately 30 to 35 RPM. The # 3 remote (SP & SP2 models) controls the pull tongue swing movement, keep tractor flow turned low to have slow steady movement. **Always have combine directly behind tractor before backing or transporting.** The # 3 (straight pull model) and the # 4 (SP & SP2 models) remote controls the raising and lowering of the bin. Make sure the tractor hydraulic control levers are working properly and in a direction the operator is familiar with. Changing positions of the hydraulic hoses in the tractor remote will change direction. **Do not transport or operate combine, unless bin is in retract or down position.** To determine the distance between the truck to the combine for unloading, position outer edge of dump bin straight up from side of truck box. Having an indicator rope will help. Regulate the flow of oil, so bin raises and lowers safely and slowly.

11. The vacuum fan is located in the upper rear portion of the combine and is powered by a belt system, driven by the main PTO drive. Two sizes of pulleys are used on the upper shaft. The small pulley is used when operating the threshing cylinder from 300 to 400 RPM. The larger pulley is used when operating at a higher range from 400 to 540 RPM. This change in pulleys necessary for best results in vacuum suction. A vacuum air port is provided for easy inspection of the fan and is directly below the pulley driving the vacuum fan. Inspect the fan daily, especially in high moisture situations. Build up on the fan at high speeds can cause imbalance and fan failure. When material is noticed on the fan blades it must be cleaned off for safe operation.
12. Inspect bucket elevator chains for tightness and adjustment. 110-115 RPM is the optimum bucket elevator speed to help prevent damage to crop.
13. Cylinder speed and threshing pin placement can vary, depending on field conditions from wet to dry. The concept of the cylinder using centrifugal force and higher speeds give the cylinder its low impact capabilities. As the product moves through the cylinder the threshing pins can be turned and positioned to change the amount of threshing time necessary for threshing and separating the crop. (Refer to Combine Cylinder Adjustment page.) There are 31 threshing pins spaced evenly on the auger fighting of the cylinder. It is important to keep the cylinder balanced, when adjusting the threshing pins. (See Trouble Shooting page.) Start up setting: (Refer to Combine Cylinder Startup Settings page). If concave holes are being blocked by a mat of grass or other debris, extending few pins closer to the concave will help keep the concave clean. Cylinder speed and threshing pin placement need to work together for efficient separation. Increased cylinder speeds can cause more crop seed damage, while a slower cylinder speed will likely reduce damage. The Double Master Plus is equipped with a heavy duty 2 speed transmission that reduces the tractors 1000 RPM PTO to 540 and 390 RPM or 500 and 350 RPM. (Depending on transmission option installed). By changing the tractors RPM you will be able to obtain threshing cylinder speeds between 300 and 540 RPM.

IMPORTANT: As RPM on cylinder reduces so does the suction on the vacuum. It becomes a necessity to adjust the vacuum cover plate with a change in cylinder RPM.

15. The crop and chaff pass through the concave onto the shaker pan. The crop moves over the shaker pan toward the rear of the combine where the vacuum system removes impurities through the vacuum fan. Adjust vacuum by moving the cover plate above final

screen. Using a 3/4" wrench loosen nuts on each side of the vacuum plate. A number system is provided for reference and to help keep the plate level. The average startup setting is #4. Moving the plate higher above the final screen reduces the suction. To fine tune visual inspections are necessary. With combine in operation, watch in the area under the vacuum duct (by use of the AgCam) where the beans pass over the shaker table to the final screen. If beans are floating or bouncing up, the vacuum is too high. Raise each side of the plate equally in 1/2" (12 mm) increments until the beans start to settle and you can just see the crop barely rise off the table. Lower the plate if chaff and other foreign material is not being separated from the crop.

16. Several final screens are available, three with round holes 7/16", 1/2" & 9/16" (10, 12 and 14 mm) sizes and two with oblong holes 1/2" x 1" (12 x 24 mm) and 3/8" x 3/4" (9.5 x 19 mm). Product size will determine final screen size selection to use. There are 2 fasteners on each side of the final screen to maintain proper screen tilt. (Refer to Combine Shaker-Separator page.) Operate screen level or 1/4" to 1/2" (6 to 12 mm) higher in rear. If crop is going over the back of the screen, use a larger screen size. Lift the rear inspection flap to make sure the final screen is level (side to side). A bumper bar system provides a jolting action to shaker table and is located on rear of final screen to keep dirt clods and other materials from clogging up the screen. Adjust the bumper bar so that the center of the bar is slightly above the final screen.



Be aware of persons in the path of an operating machine! Never allow a person to stand within 33' (10 meters) of an operating machine!



Wear appropriate personal protective equipment when making repairs on this machine! Personal protective equipment may include; hard hat, dust mask, safety goggles, hearing protection, face shield, gloves and steel toed boots!



Operators must be properly trained before operating this machine!

Shaft Monitor System

Pickup head speed and on—off function is controlled by the touch screen monitor.

Pickup head on and off buttons.

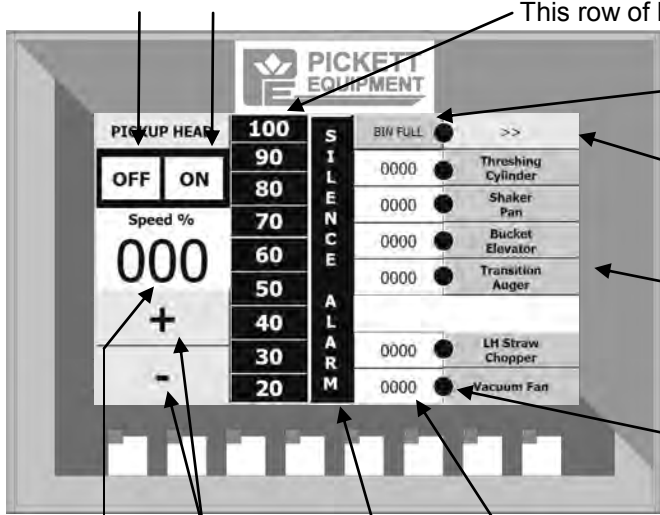

This row of buttons changes the pickup head speed to this percentage.

Changes to Bin Full and alarm sounds. Must be acknowledged every bin full.

Changes screen to the next page.

Function description—individual alarms can be disabled by touching the description. Alarm will reset when function returns to the normal speed range.

Dots appear to help quickly identify which function is causing the alarm.

Changes percentage by 1 percent.

Speed readouts for each function.

Pickup head speed percentage.

Silences alarms until any function returns to normal.

Pickup head on—off buttons and speed percentage shown on all pages.

Invisible button resets limits to the default setting. (Hold for 4 sec.)

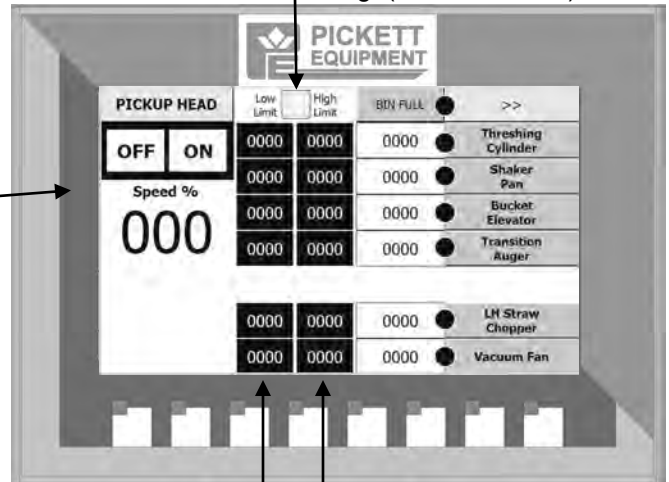

Limits change the speed at which the alarm is triggered. Allowance for normal speed variation needs to be observed to keep the alarm from sounding prematurely.

Button returns you to the pickup head control page.

Invisible button toggles between Twin and DMP modes. The active mode is displayed. (Hold for 4 sec.)



Page gives average combine speeds and basic operating instructions.

The hour meters are activated by turning on the pickup head. The lower one can be reset to zero by holding the button.

Function buttons at the bottom of the monitor are the same on all of the screens. These are duplicates of commonly used buttons found in the touch screen portion of the monitor.

Shaft Monitor System

Pages 4 & 5 give information on the monitor operation and the optional bin weight system. (Bin weight system not available for DMP models.)

The sound of the alarm buzzer can be changed by varying the pulse percentage rate.

Button advances you to the next page.

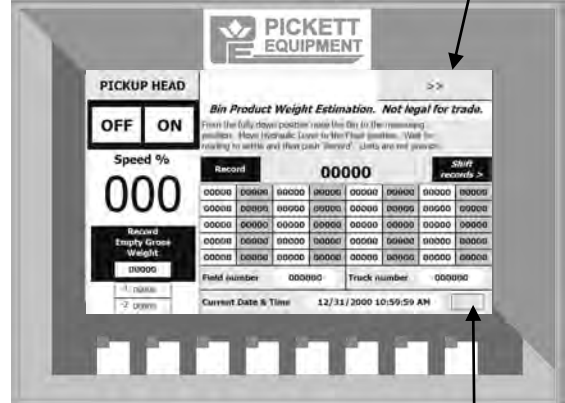
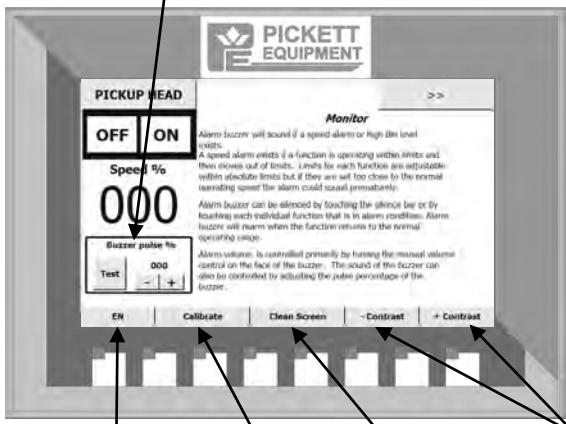

Button toggles through the available Languages.

Contrast buttons allows the operator to change the screens brightness.

Invisible button allows you to change the date and time. (Hold for 4 sec.)

Calibration function needs to be preformed after the scratch protective cover on the touch screen is replaced. Follow the on screen instructions. No other action can be taken during this process.

Clean Screen button gives you 1 minute to clean the screen. No action intentional or accidental can be taken during this time.

The pickup head speed is controlled by a proportional valve driver. The driver is located inside of the white enclosure. The driver is controlled by a signal from the touch screen monitor.



Settings & Range:

- HI : high, output current corresponding to the highest input, 0.00 to 3.00 A
- Jg : jog, used to simulate input
- LO : low, output current corresponding to the lowest input, 0.00 to 3.00 A
- UP : ramp up, time required for the output to increase from LO to HI , 00.0 to 99.9 s
- dn : ramp down, time required for the output to decrease from HI to LO , 00.0 to 99.9 s
- db : deadband, output is disabled when command signal is less than this setting
- dF : dither frequency, 50 to 500 Hz
- in : input signal selection
- di : display orientation, normal or up-side-down
- SA : save settings

(Factory Settings)

- (1.60)
- (0.35)
- (01.5)
- (01.5)
- (005)
- (100)
- (010)

Set-Up Procedure:

At power up, you may rotate # to read *ot* (output) the actual solenoid output current in Amps. Or *in* (input) this is a PWM (pulse-width modulation) signal. To enter set-up mode rotate *, the display will show the settings sequentially: HI, Jg, LO, UP, dn, db, dF, in, di and SA. When you reach the setting that you want to modify, rotate # up or down to the desired value. To modify another setting, rotate * and repeat. The Driver is fully functional during the set-up procedure with any adjustments effective immediately. In order to write the new settings in the memory and return to normal mode of operation, rotate * until the display shows SA and then rotate #. If you do not want to keep the new settings, you may disconnect and reconnect the Driver from the power supply.

Shaft Monitor System

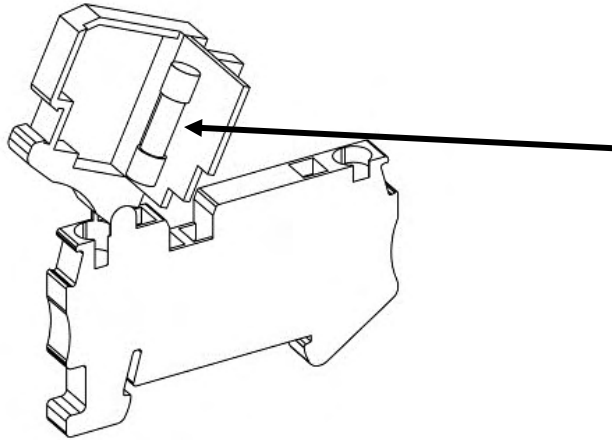

Each monitor system has 2 fuses located in the lower right hand corner of the white monitor enclosure. The one on the right is for the 12v to 24v power converter. The one on the left is 12v for the pickup head and the tongue tilt.

To change a fuse there is a door on the top right side of each fuse holder. This door opens to the right. Snap the fuse into the holder on the door then close the door. The upper portion can be rotated for clearance between the other terminal blocks.

Fuse # GMA—15A
Pickett # 106083

AgCam System

NEVER RELY ON YOUR AGCAM AS A SAFETY FEATURE. It is up to your discretion to keep your road travel and other operations safe. Your AgCam will provide you with information only based on what it sees operation of machinery safety guidelines still apply.

AgCam Monitor Operation

Before turning you monitor on, make sure it is supplied with power and cameras are connected. Turn you monitor on by pushing the “power” (on the face of monitor or on remote). If you do not see a picture, you may need to switch to another video (camera) input selection by using the button marked “AV” on monitor and remote, depending upon the number of cameras being utilized.



1. Extendible antenna (analog).
2. **ANT**: external antenna jack.
3. **EAR**: earphone jack.
4. **MENU**: active OSD menu, press this key and select the setting object that you want to adjust with the help of the 8 or 9 button.
5. **-**: Volume (in OSD), press this key to turn down the volume and adjust the setting value of the menu.
6. **+**: Volume (in OSD), press this key to turn up the volume and adjust the setting value of the menu.
7. **CH+**: to select the program and the setting object in the menu.
8. **CH-**: to select the program and the setting object in the menu.
9. **AV**: to select the input signal.
10. **POWER**: On/Off/Standby
11. Audio/Video In (white band indicates audio enabled input)
12. Video In – 2nd Camera
13. Power Input (A/C or 12v)

AgCam System

Remote Control Functions for Monitor

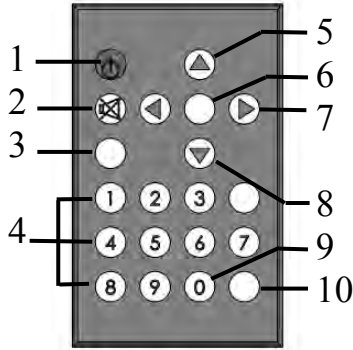

1. **Power:** On/Off/Stand by.
2. **Mute:** Press this key to close the sound, press it again to return the sound.
3. **AV/TV:** to switch between TV signal and Video Signal.
4. **Menu:** Active OSD menu, press this key and select the setting object that you want to be adjusted by the help of the 5 or 6 button.
5. **CH+:** Program selection.
6. **CH-:** Program selection.
7. **V-:** Volume (in OSD), press this key to turn down the volume and adjust the setting value of the menu.
8. **V+:** Volume (in OSD), press this key to turn down the volume and adjust the setting value of the menu.
9. Numbers buttons: **0-9**.
10. **Wide:** Select the display mode of image (16:9 or 4:3).

Menu Operation—To allow changes in the picture settings, press the menu key on the unit or remote. Use CH-/CH+ to select item (the selected item turns red) U V-/V+ for adjusting the value. Press Menu key to return to main menu. *Note*—if you stop operating the unit for a few seconds it will automatically exit out of the menu.

Video—Pressing the menu key will immediately bring you to the video menu to adjust brightness, contrast, color, sharpness or tint. You can do so by pressing the CH-/CH+ key to select which item you would like. Use the V-/V+ keys to adjust the value for any of these settings.

Audio—Next by pressing the V+ key you will go to the audio item. Press CH-/CH+ to select the volume and press V-/V+ to adjust volume.

Setup—To continue press V+ and this will bring you to the set up item. You can choose the language you desire, Chinese, English, Russian, German or French. Press CH-/CH+ to select then V-/V+ to change the language.

- To setup screen background setup press CH-/CH+ key to choose background, then press V-/V+ key to choose ON/OFF (when there is no signal, the background is blue.)
- To adjust the display state of the screen size press CH-/CH+ key to select "Mode" and V-/V+ to adjust. When you select "1" the display status is 16:9 (Full screen display), "2" it is 4:3, "3" is 16:9 in full screen display and "4" is 4:3 on the right.
- The unit has the function of image. "Up and Down Reverse" and "Left and Right Reverse". Use CH-/CH+ to select "UV Rev" or "RL Rev". Then press V-/V+ on the remote to control image of "Up and Down Reverse" or "Left and Right Reverse".

Tuner (Analog) - This TV has an analog tuner. You can use a conversion box to receive digital TV signal.

Lights and Signals

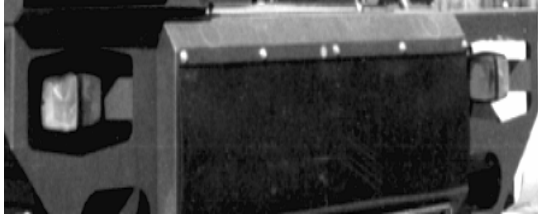

Combine lights are wired to come on when tractor light switch is turned on.

Lights must be turned on when transporting

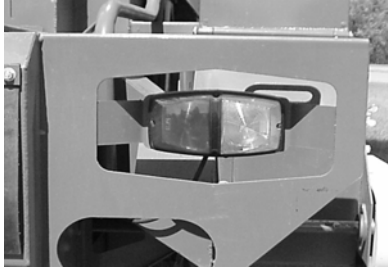

Combine signal lights operate with the Tractor turn signal lever.



When transporting on a road, flashing lights give warning to other drivers. These lights are located on both sides at the rear of the combine.

Lights are positioned on the outer, left and right, rear corners of the combine.



This light inside the bin should give adequate lighting for night work.

Setting Up The Tractor DMP Straight Pull

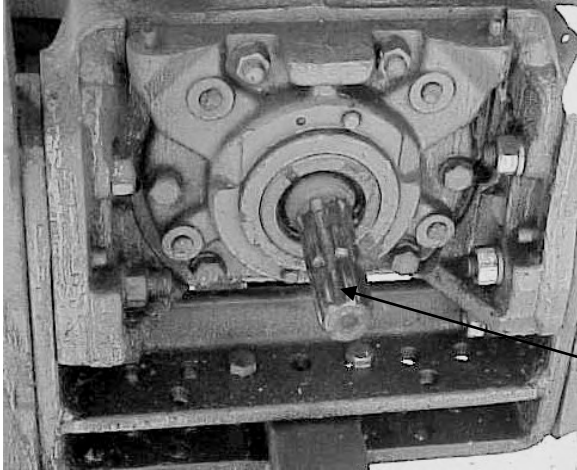

540 PTO shown for illustration only

Tractor PTO Speed

This combine is equipped with a 1000 RPM, (Walterscheid) power takeoff. Both 1 3/8" 21 spline and 1 3/4" 20 spline are available.

Clean and lubricate PTO shaft with high temperature EP grease before attaching PTO driveline.

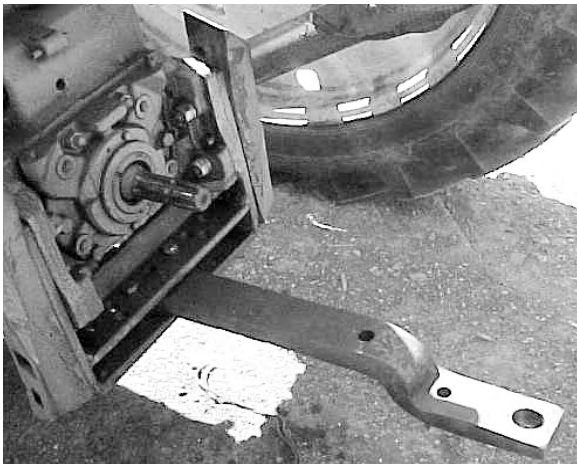

Shield removed for illustration

Adjusting Drawbar

1. Adjust tractor drawbar to measure 16 in. (40.5cm) from end of PTO shaft to center of hole in drawbar for 1 3/8" 21 spline and 20 in. (50cm) for 1 3/4" 20 spline.

2. Adjust drawbar for 6-12 in. (15-30cm) clearance between PTO and drawbar, and 18-20 in. (45-50cm) clearance from the drawbar to the ground.

3. Position drawbar to align hitch pin hole with centerline of tractor PTO shaft. Do not pull combine in a offset drawbar position.



Adjusting Tire Spacing

Tractor tires should be set out wide enough to straddle the crop windrow to minimize crop damage.

Setting Up The Tractor

DMP SP & SP2



Tractor PTO Speed

The Double Master Plus is equipped with a 1000 RPM, 1 3/4" 20 spline or 1 3/8" 21 spline (Walterscheid) driveline.

Clean and lubricate PTO shaft with high temperature EP grease before attaching PTO driveline.



Shield removed for illustration

Adjusting Drawbar

1. Adjust tractor drawbar to measure 16 in. (40.5cm) from end of PTO shaft to center of the drawbar hole for 1 3/8" 21 spline or 20 in. (50cm) for 1 3/4" 20 spline drivelines.
2. Adjust drawbar to 18-20 in. (45-50cm) clearance from the top of the drawbar to the ground.
3. Position drawbar to align hitch pin hole with centerline of tractor PTO shaft. Do not pull combine with the drawbar in a offset position.

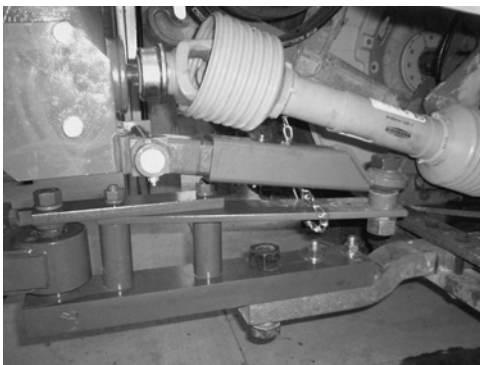

Swivel Gearbox Stabilizer

Assemble drawbar extension and swivel gearbox stabilizer as shown. Use care to determine that it will move in all desired positions without binding. Check daily for loose bolts and proper movement. Lube daily.



Adjustable Pull Tongue

The pull tongue can be adjusted to keep combine level for operation, regardless of the tractor drawbar height.

Pull tongue equipped with a heavy duty Dura-ball.

Complete Drive Train DMP SP & SP2

Primary Driveline



Lubricate crosses every 8 hours
Telescoping members must be lubricated either through zerk in telescoping member or by taking apart every 8 hours

Lubricate guard through molded nipples every 8 hours

Attach guard safety chain to a secure location

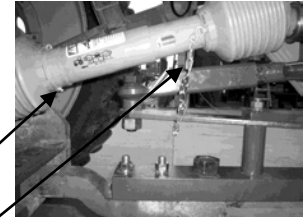

Secondary Driveline & Swivel Gearbox



All driveline crosses, telescoping members and plastic guards must be lubricated every 8 hours

Swivel gearbox use SAE 80W-90 (2 places on the tractor side of the boxes) upper oil capacity 4.9 pt (2.3 L) lower oil capacity 4.4 pt ((2.1 L) check 25-30 hours

Cut-out clutch clamping cone bolt torque to 75 ft lbs. (102 Nm)
Cut-out clutch requires no service
If overload occurs disengage tractor PTO after it completely stops reengage slowly

Attach guard safety chain to a secure location

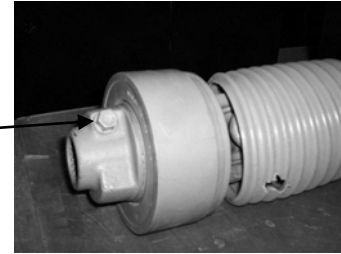

Tertiary Driveline & 2 Speed Transmission

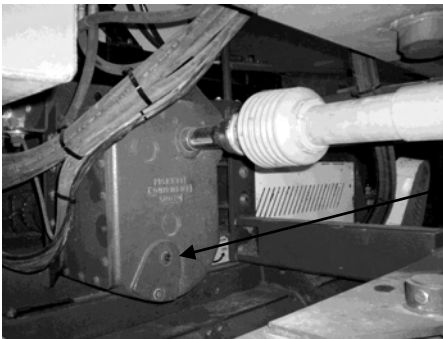

All driveline crosses, telescoping members and plastic guards must be lubricated every 8 hours

2 Speed Transmission use Synthetic SAE 75W-90 check daily, oil level is the center of the sight glass oil capacity 8.5 pt (4 L)

Overrunning clutch is located at the forward end of the Tertiary driveline. Lube every 8 hours

Attach guard safety chain to a secure location

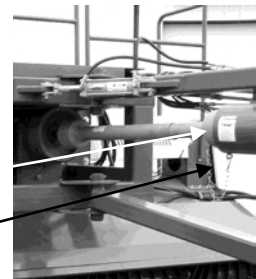

Note: Operating combine at maximum tongue offset angle will shorten driveline bearing cross life. Use minimum offset to keep tractor from running on the crop.

2 Speed Transmission Shifter

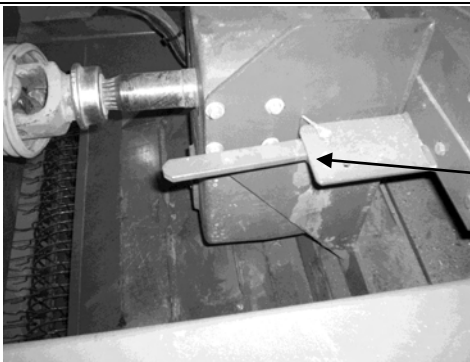

Transmissions shifted by the shift lever located on the left hand side of the transmission.

Complete Drive Train



1000 PTO Input Speed & CV.

The Double Master Plus Straight Pull is equipped with either an 1 3/4" 20 spline or an 1 3/8" 21 spline (Walterscheid) driveline with CV joint.



Straight pull model.

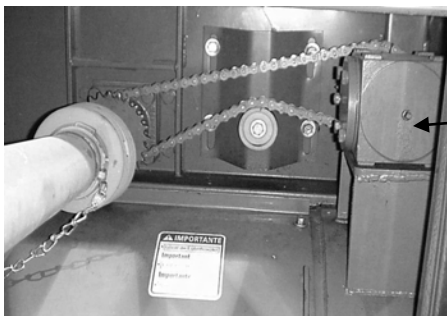

Transition Auger Drive

The transition auger 90° gear box is chain driven by the threshing cylinder. Use **Synthetic SAE 75W-90** check every **25-30 hrs.** hours. Oil capacity 1.6 pt (.8 L).

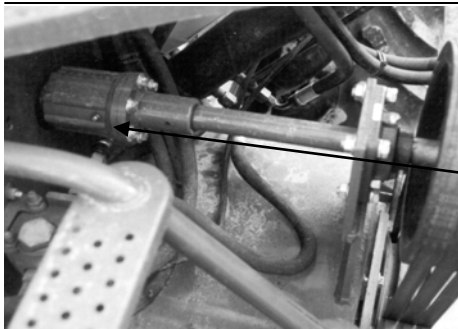

Radial Pin Clutch & Drive Shaft

The radial pin clutch is on the other side of the 90 degree gear box pictured above. The shaft drives the transition auger pulley.

Feeder House

Transition Auger Drive

The final drive for the transition auger is either belt or chain driven, (depending on model) located on the left side of the combine.

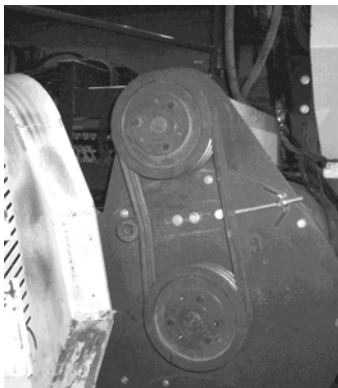

Intermediate Star Feeder

The intermediate star feeder is chain driven from the transition auger on the right side of the combine.

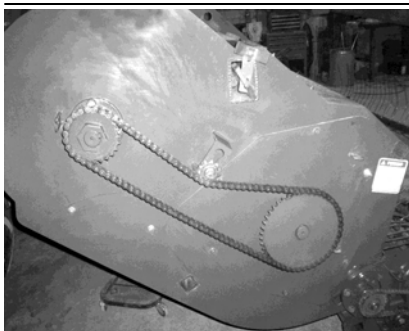

Feeder House

Pick Up Head Drive



Round roller and pickup head are hydraulically driven by a variable speed motor, for gentle handling and positive feeding of the crop.

Pick Up Head



Pickup head is equipped with adjustable hold down rods for smooth feeding.

Adjustable gauge wheels allow the pickup head to follow uneven terrain.

Pickup head is chain driven from the round roller on the right side of the machine.

Adjustable Pull Tongue



The pull tongue can be adjusted to keep combine level for operation, regardless of the tractor drawbar

(DMP Straight Pull shown)



Concave Separator & Threshing Cylinder

Concave Separator Sieve

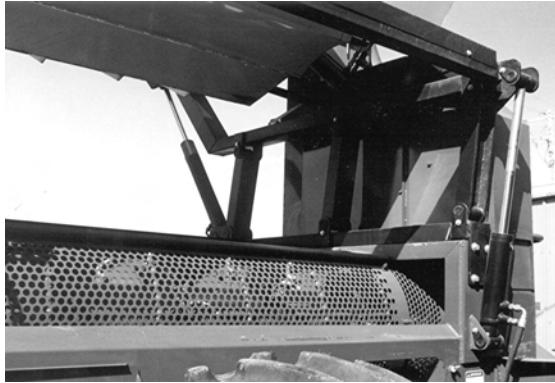

The perforated concave allows the seed to fall to the shaker pan as soon as it is threshed out of the pod. Concave bars are on the inside of concave.

The cylinder and concave are easily accessible by raising the bin.



The threshing cylinder is directly underneath the bin. The bottom of bin serves as a lid for the top of the threshing cylinder. When combine is operating the bin needs to be completely lowered enclosing the cylinder.

Before making any adjustments to the combine cylinder

TURN OFF TRACTOR!!!

REMOVE KEY FROM TRACTOR IGNITION!!!

ALWAYS EMPTY BIN BEFORE MAKING ADJUSTMENTS!!!

Low Impact Threshing Cylinder

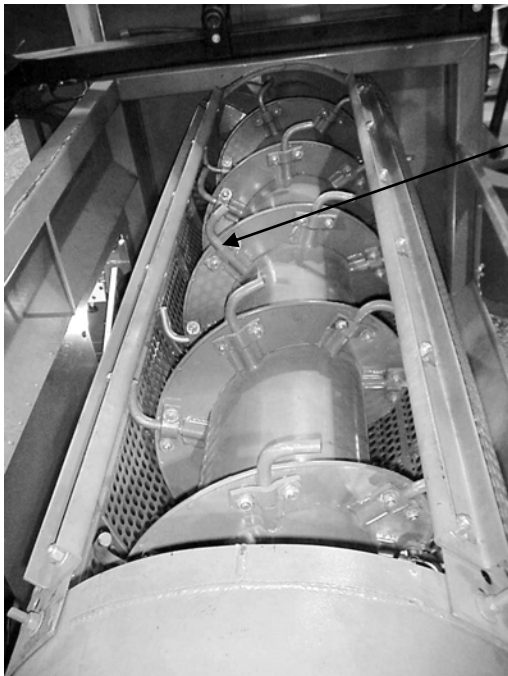

Cylinder threshing pin. These pins can be adjusted by loosening the carriage bolts that hold the clamp. With the clamp loose, pins are able to rotate, also move in & out.

Rotating the pins forward, against the flow of the material, causes a slowing of material travel, thus increasing the amount of threshing in the cylinder. Rotating the pins more in the direction of material flow reduces threshing. Pins are normally all of the way down in their pocket. If concave holes are being blocked by a mat of material, such as grass, extending a few pins out, closer to the concave, will help keep concave holes open.

Concave Separator & Threshing Cylinder

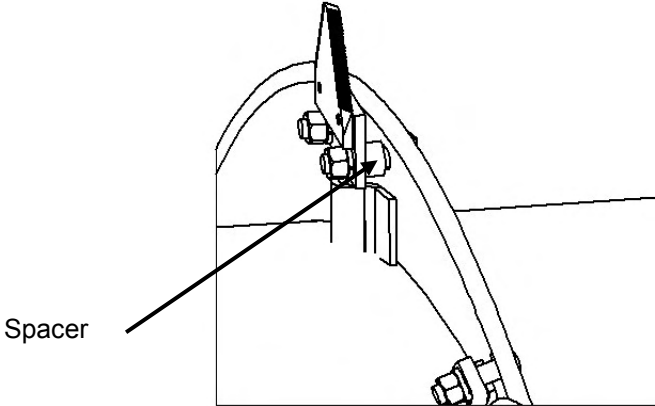
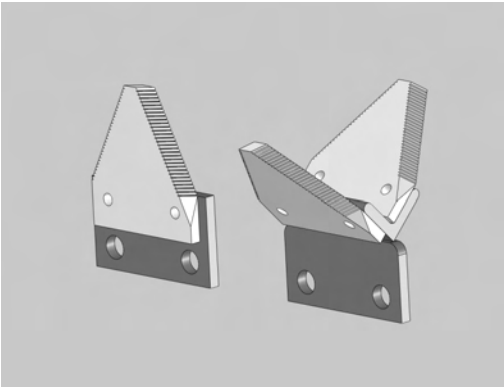

Two knives come standard on all new combines normally replacing the 1st and 4th pins. These knives cut, separate and distribute the material evenly in the front of the cylinder. Place the knife on the same side of the flighting as the pin would go use a 9/16" (14 mm) spacer as shown so that the knife cuts straight through the material. Two types of knives are available single blade and double blade. The only time that a double knife is recommended is when threshing very sporadic and inconsistent windrows. This will cut separate the material more evenly not only in the cylinder but coming out of the combine as well.

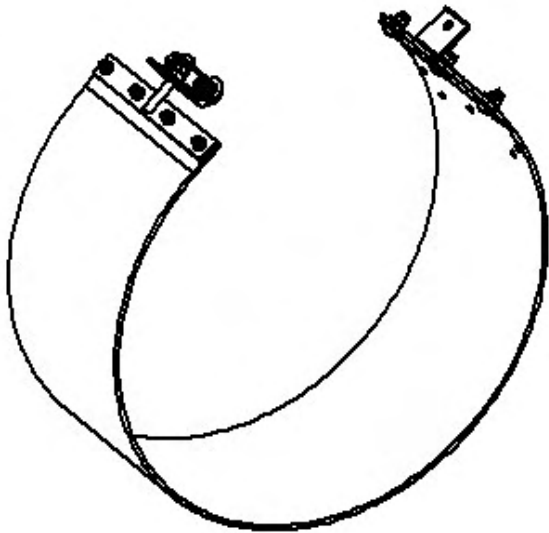

A concave cover belt comes standard on all new combines. This cover belt will not allow whole pods to fall onto the shaker table. They will also hold the material in the cylinder longer helping to distribute the beans across the shaker table more evenly.

When the cover belt is not needed it can be folded in half and left hanging in the combine. The only time the cover belts are not recommended is in extremely weedy conditions, especially nightshade.



Warning

Before making any adjustments to the combine cylinder
TURN OFF TRACTOR!!!
REMOVE KEY FROM TRACTOR IGNITION!!!
ALWAYS EMPTY BIN BEFORE MAKING ADJUSTMENTS!!!

Combine Cylinder Adjustment

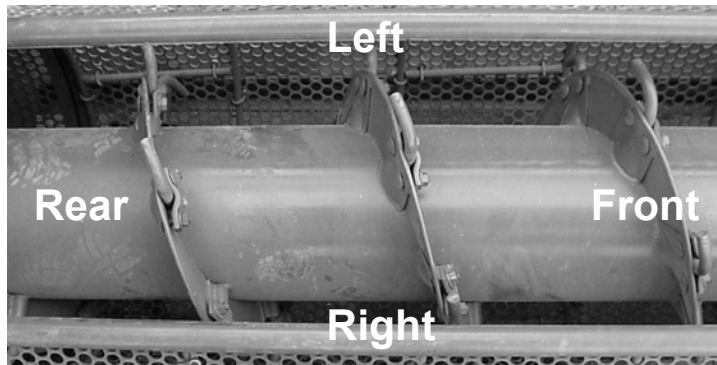

Combine main threshing cylinder with 31 threshing pins.

The pin setting determines the amount and type of threshing to the material.

Views below Left Right ← →	Clock references below are from the right side of the machine facing the left side.	Views below Rear Forward ← →
	<p>Threshing pins in <u>neutral</u> position Or 30° rearward</p> <p>Quick movement of material Neutral setting for gentle thresh</p>	
	<p>Threshing pins at the <u>2:00</u> position Or 60° forward</p> <p>Slower material travel Hard thresh setting</p>	
	<p>Threshing pins at the <u>1:00</u> position Or 30° forward</p> <p>Medium material travel Medium thresh setting</p>	
	<p>Threshing pins at the <u>12:00</u> position Or 0°</p> <p>Increased material travel Gentle thresh setting</p>	
	<p>Threshing pins at the <u>10:00</u> position or 60° rearward most gentle thresh setting</p>	

Combine Cylinder Startup Settings

It is important to understand the fundamentals of how the central flow threshing system works. This system does not rely on a hit or rub to dislodge the beans from the pod. This system uses centrifugal force to gently separate the seeds from the plant and move the seeds to the shaker table. This is why it is important to keep constant pressure or power in the threshing cylinder and by operating the threshing cylinder at a speed that will not damage the seed. Cylinder speeds of 290 to 360 RPMs in almost every case will deliver quality seed. This will allow the tractor to stay above 1800 RPM and keep the time required for recovery in the threshing cylinder constant. Operating the cylinder at higher speeds will not increase the capacity of the machine; however it will cause parts to wear out quicker. Capacity is determined by the amount of chafe and beans on the shaker table and final screen. With the aid of the AgCam determine that seed is never going beyond the middle of the final screen while in operation. This will allow the vacuum system to adequately remove the foreign material. Keep threshing pins in good condition; in most cases if beans are going out the rear of the machine, it is because the pins in the first two sections of the threshing cylinder are worn out and should be replaced.

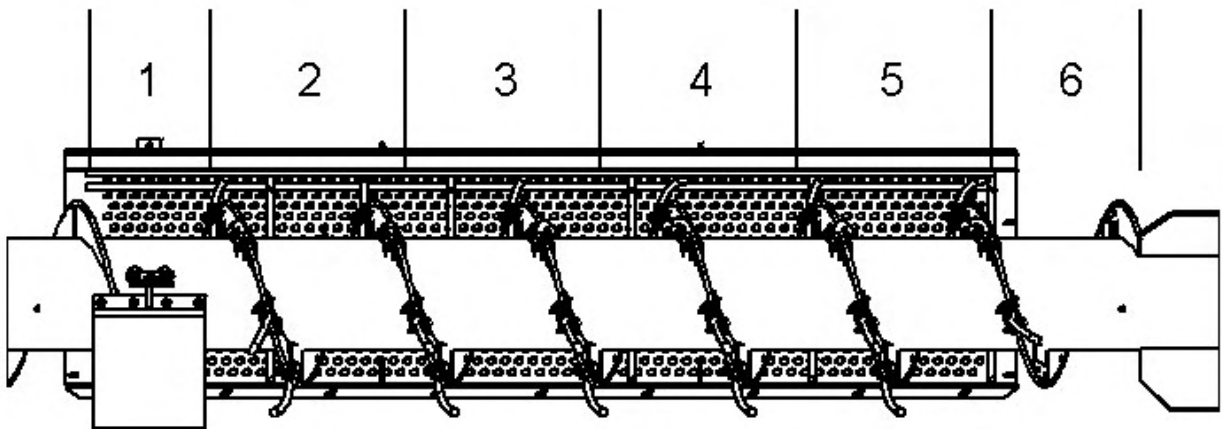

1. This is the knife and cover belt section. Knives normally replace pins 1 & 4. The remaining pins are set at neutral. The cover belt will not allow whole pods to fall onto the shaker table. It will also hold the material in the cylinder longer and help distribute the beans across the shaker table more evenly.
2. This section is where the threshing begins. Set 3 to 5 pins at 0° to 30° forward, with the remaining pins set at neutral.
3. This is where the majority of the separation takes place. Set all pins at neutral, at this time most of the seeds are on the shaker table being polished by the leaves.
4. This is the stirring section. Set 3 to 4 pins alternately at 60° forward and 60° rearward with the remaining pins set at neutral. This creates an irregular motion in the material allowing the seeds to separate from the straw.
5. This is the final separation and stirring section. Set the last 3 to 4 pins alternately 60° forward and 60° rearward with the remaining pins set at neutral.
6. This final section is the discharge. All pins should be removed from this section. The last pin in the cylinder should be where the last concave bar is located.



Before making any adjustments to the combine cylinder

TURN OFF TRACTOR!!!

REMOVE KEY FROM TRACTOR IGNITION!!!

ALWAYS EMPTY BIN BEFORE MAKING ADJUSTMENTS!!!

ALWAYS ENGAGE MANUAL BIN SAFETY LOCKS!!!

Combine Shaker-Separator



Shaker Pan Area

The shaker pan should be operated at a speed that allows the crop to move at a steady even flow. If the crop bounces up from the pan the shaker speed is too high. 325-330 RPM on the shaker shaft is a good starting speed.

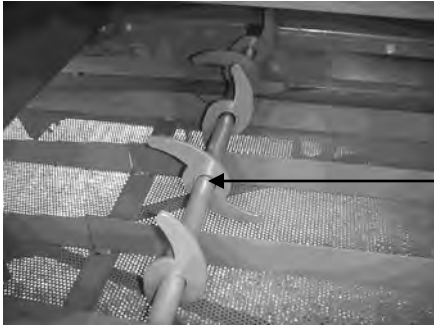

Straw Walker Shaft

The straw walker aids in the movement of the straw and stems underneath the vacuum suction port. The straw walker also stirs the material allowing the heavier crop to fall below the lighter straw and chaff, allowing the vacuum to clean the crop more efficiently.



Shaker Pan Springs

The shaker pan should be centered in its operating area so it does not come in contact with other parts during operation. There are 4 sets of 6 springs on the shaker pan. This allows for proper shake of the pan and crop movement.

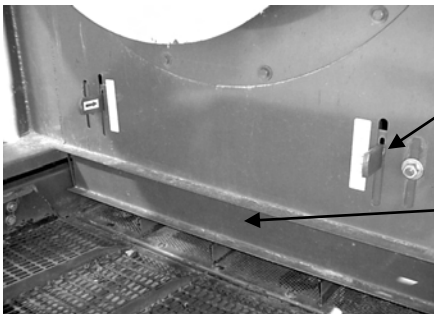

Vacuum Fan Adjustment Plate

The vacuum fan is positioned directly over the shaker pan for cleaning the foreign particles out of the crop, as the shaker pan moves the crop material directly underneath the vacuum at an even flow.



Final Shaker Sieve Adjustment

This sieve should operate on as low of an incline as possible, without the crop spilling over the back and still allow the large foreign materials to ride over the back of the sieve. This concept will work best for maximum cleaning and maximum capacity.

Final Sieve

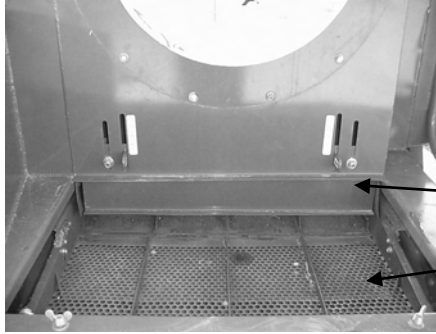

This is the final shaker sieve, where the last of the cleaning takes place before the crop is lowered to the elevator auger.

Vacuum adjustment over sieve area.

Final sieve

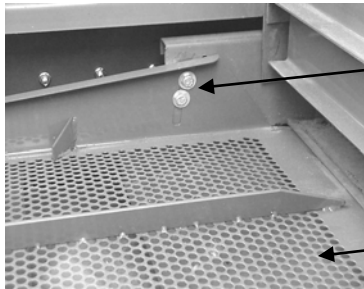

The sides of the sieve are slotted to allow the sieve angle to be adjusted. A slight incline in the rear will allow the crop time to fall through the sieve and larger material to shake off the end of

Round hole style sieve, round hole type sieve will work better in conditions where small dirt clods might be present.

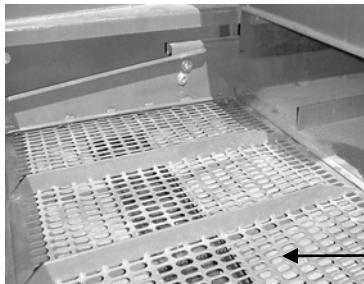

Two types of holes on the sieves are offered. **Round hole** sizes 7/16", 1/2" & 9/16" (10, 12 & 14 mm)

Oblong hole sizes 1/2" x 1" (12 x 24 mm) and 3/8" x 3/4" (9.5 x 19 mm)

Oblong hole style sieve



To remove sieves, remove the two adjustment bolts on each side, lift up rubber flap and pull sieve straight out.

An adjustable bumper bar is installed to add more vibration and shake to the final sieve. This extra action will help keep the small dirt clods from sticking in the sieve holes.

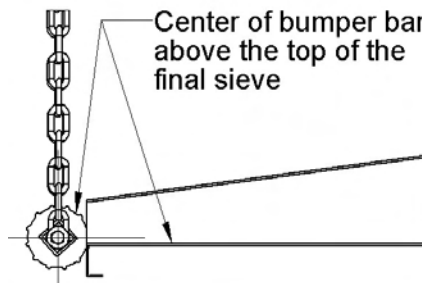
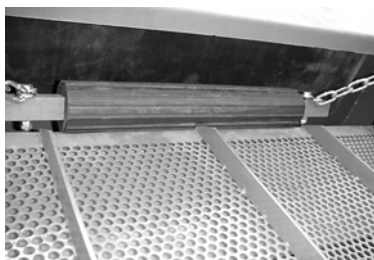

Vacuum Cleaning System

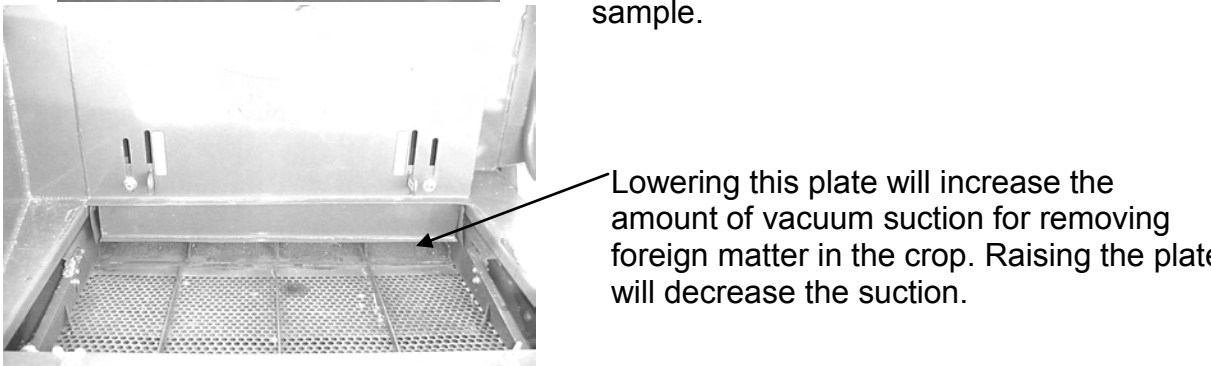
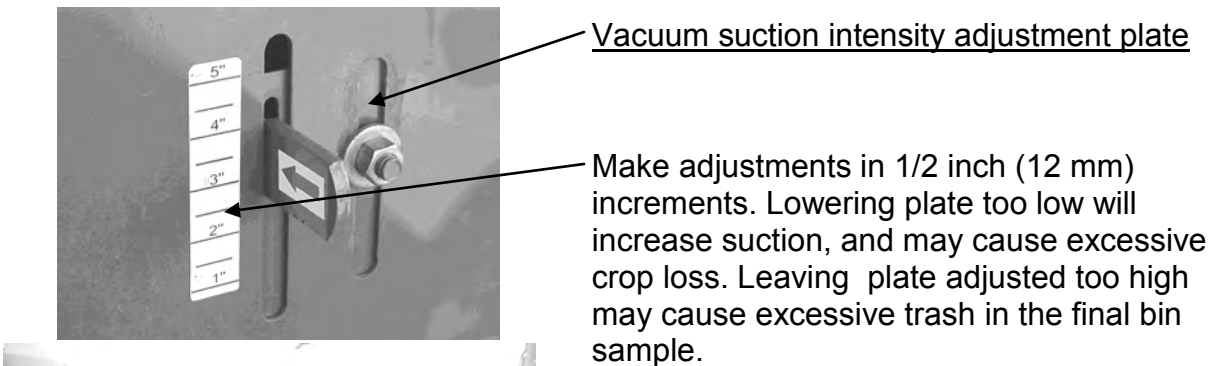
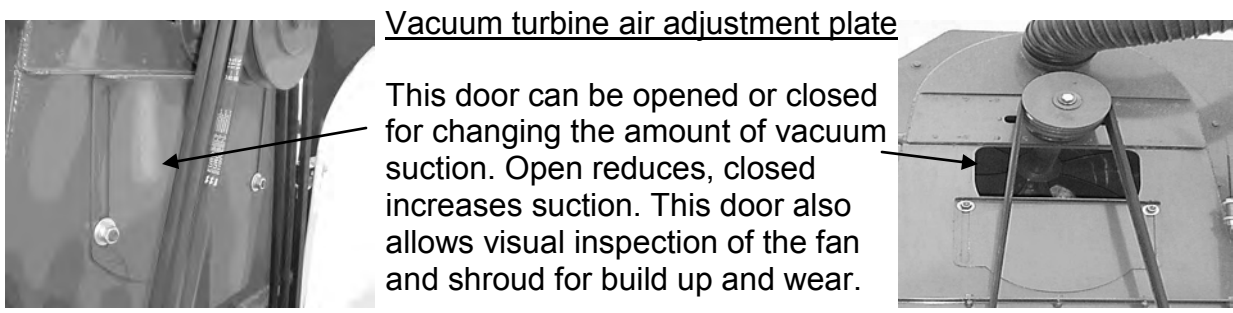
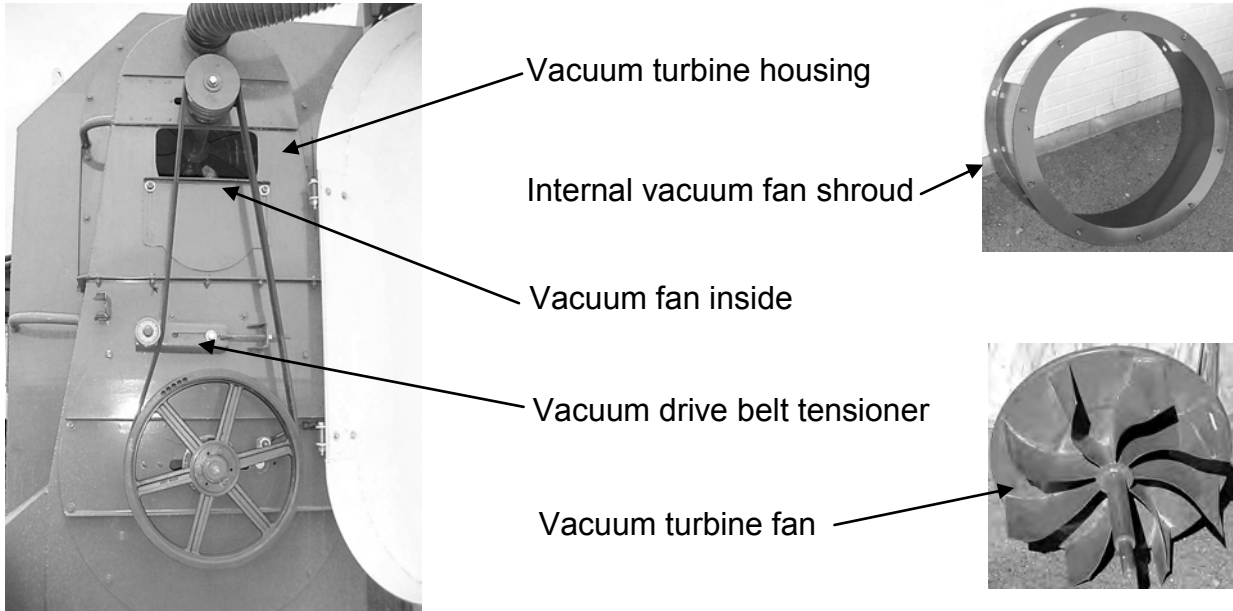

Bucket Elevator



Vacuum suction hose has been discontinued.

Vacuum fan drive behind shield

Bucket chamber inspection lid

Drive chain for the elevator auger

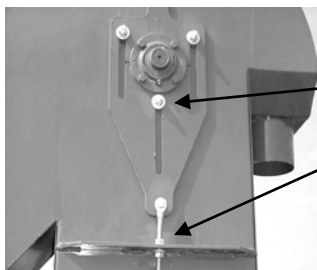

Elevator bucket chain tensioner & adjusting bracket.

When tightening the bucket chain, both sides need to be adjusted evenly to keep the buckets centered. Do not over tighten the bucket chain. The chain should have approx. 3/4" (19 mm) deflection, in or out, from straight.

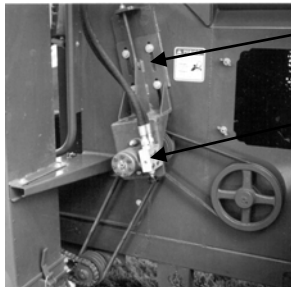

Elevator Drive belt tensioner

Hydraulic variable speed drive, (with control knob at the motor area) for elevator cross auger, shaker pan, and bucket elevator.

Elevator shaft speed should run between 110 to 115 RPM.



Elevator discharge into holding bin. Crop is moved along with the hydraulic driven, leveling auger which aids in filling the bin to capacity.



Bottom latch door for easy cleanout.

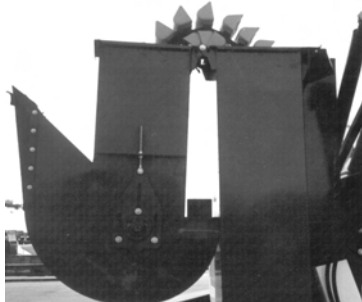

⚠ WARNING

Elevator Erected Height Is 15' 2" (465 cm)

During transport, the elevator leg can be folded down at the hinge point.

Unloading System



Note! To prevent damage to the bin lifting system, the combine must be completely stopped before raising or lowering the bin.



Two bin cylinders lift the dump bin to unload the bean crop into an awaiting truck.

Safety feature The counter balance valves (one located on each dump bin cylinder) are hydraulic safety locks, to keep the bin from being lowered, as long as the tractor is not running.



⚠ WARNING

**With Dump Bin Raised Height Is 22' 2"
(676 cm)**

OBSERVE OVERHEAD OBSTACLES

Shaft Monitoring System

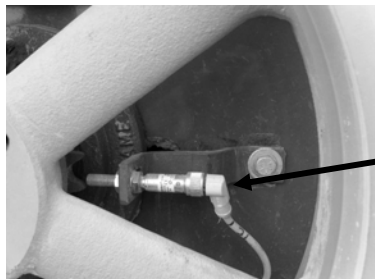

Threshing cylinder sensor

This sensor reads the RPM of the main threshing cylinder. It is located on the rear of the Threshing cylinder.

All sensors should be no farther than 1/8" (3 mm) away from the object it detects.

Threshing cylinder RPM range 540 to 300.

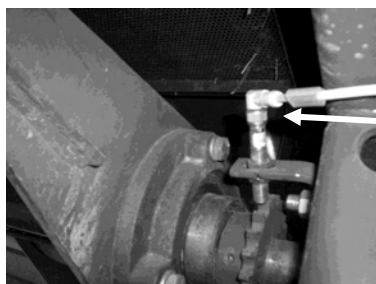

Shaker pan drive-shaft sensor

This sensor reads the RPM of the shaker drive shaft. It is located under shaker pan on the main shaker shaft.

The setting of this shaft should be approximately 330 RPM.

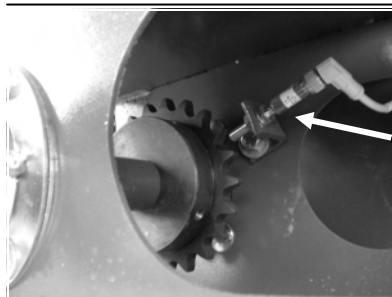

Bucket elevator speed

This sensor reads the RPM of the bucket elevator. It is located on the lower bucket elevator shaft.

The setting of this shaft should be approximately 115 RPM.

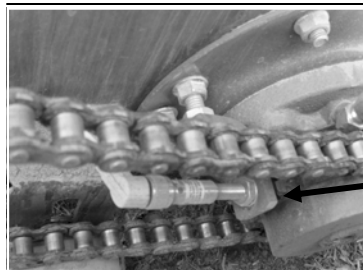

Transition auger sensor

This sensor located on the right hand end of the transition auger detects motion of the shaft. If the motion stops the alarm will sound.

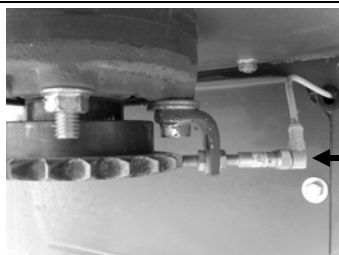

Straw chopper sensor

This sensor located on the bottom of the straw chopper and detects motion of the shaft. If the motion stops the alarm will sound.

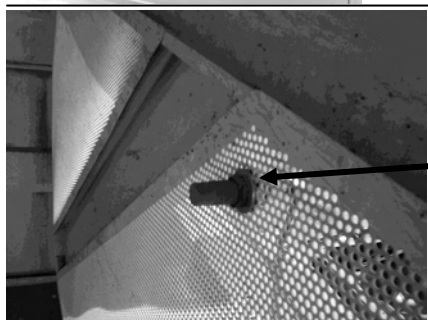

Bin full sensor

A bin level sensor is located on the front inside near the top of the bin. When the bin is full the switch is activated and the alarm will sound.

Appearance and location of sensors may vary.

Cleaning Out the Combine

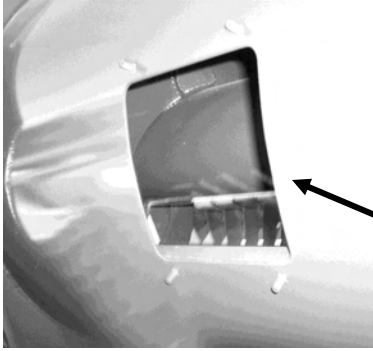

Cleaning the combine can be done with ease, in a short period of time.

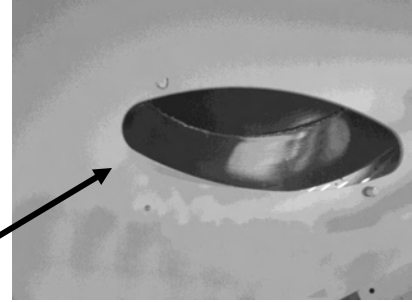

Remove the covers from the ends and rear of the transition auger and use air pressure for cleaning.

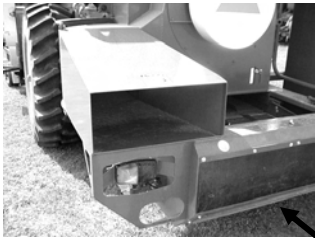

Rear Discharge

Operate combine shaker pan & bucket elevator long enough to visually see the area is clean. This final sieve area should mostly self clean by allowing the machine to run.

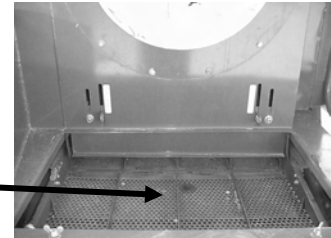

Rear Sieve

Clean out the final inspection holding area behind the rubber flap.



Raise dump bin to make sure it is clean, using a broom or air pressure. With dump bin in the raised position, a visual inspection can be made to the shaker pan area as well as the cylinder for final cleaning.

The shaker pan area should self clean by allowing the combine to run.

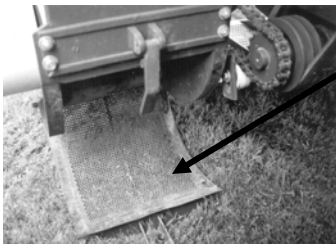
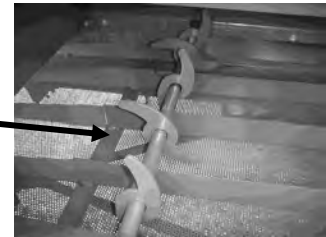

Unlatch the trap door on bottom of the elevator leg for cleaning. Operate machine long enough to make sure all buckets are cleaned out.

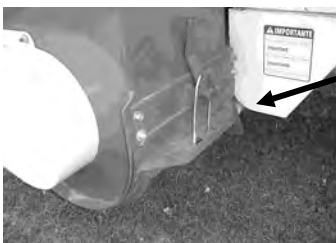
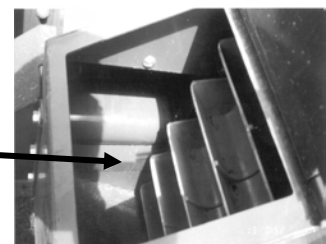

Once the combine is clean, replace all the lids and shields, lower the bin and you are ready for the next field.

Lubrication and Maintenance

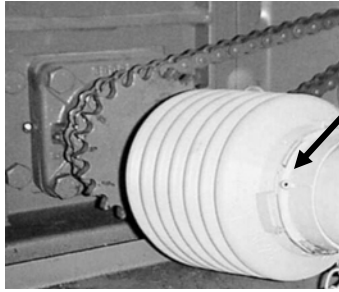

Driveline shield grease nipple.
8-10 hrs

Gear box lube fill & level plug.
Oil capacity 1.6 pt (.8 L)

Check daily
Synthetic SAE 75W-90

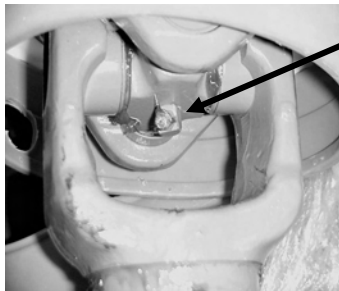
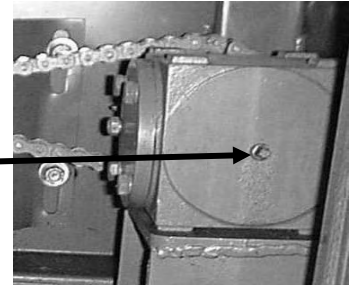

Lube all driveline cross joints
every 8-10 hrs.

Lube sites for CV joint. Lube
every 4-5 hrs.

Always attach driveline
shield safety chain.

Straight pull DMP shown.

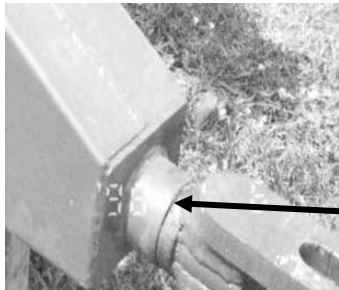
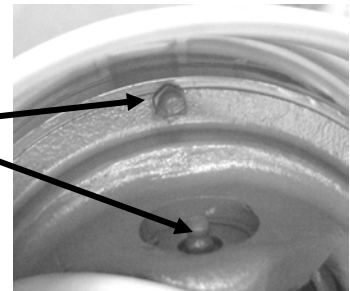

Rear hitch swivel shaft on pull
tongue.

8-10 hrs.

Front hitch swivel shaft on pull
tongue.

Straight pull DMP shown.

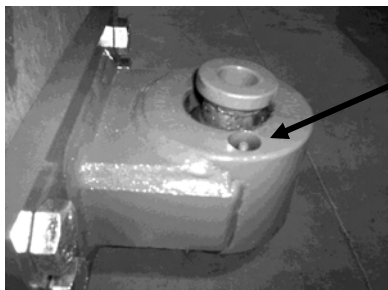
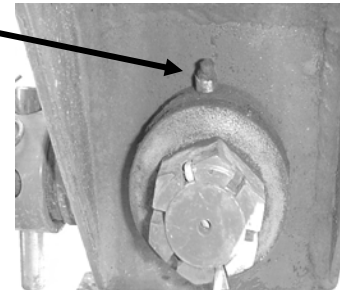

Dura-ball located on swing tongue.

8-10 hrs.

Swing tongue pivot pins
(2 places).

SP & SP2 Models

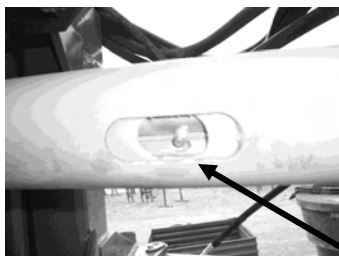
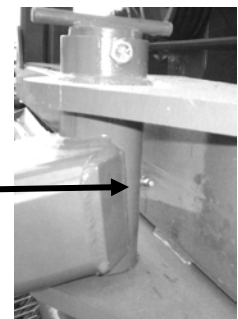

Lube primary drive shaft bearing
every 8-10 hrs. through safety
shield.

Overrunning clutch located
under shield.

Driveline telescoping members.
Drivelines without zerk need to
be taken apart and lubed.

Straight pull DMP shown.

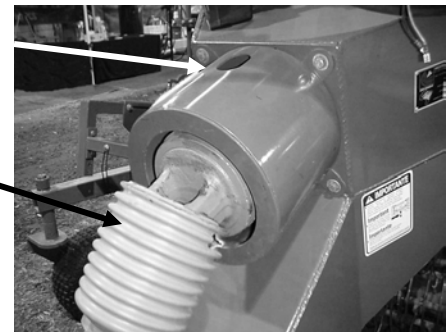

Lubrication and Maintenance

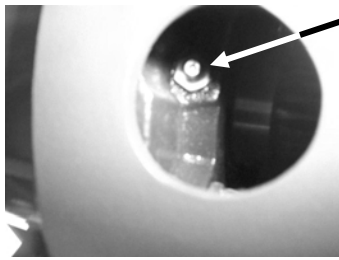

Stationary driveline bearing
(2 places).

8-10 hrs.

Overrunning clutch on the
tertiary driveline.

SP & SP2 Models

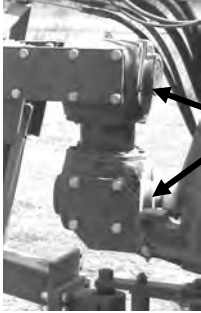
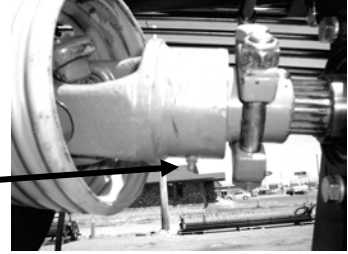

Swing tongue ram
(2 places). 8-10 hrs.

Top and bottom halves of the swivel gear
box have separate oil level plugs. The level
plugs are on the tractor side of the gear box.
Upper oil capacity 4.9 pt (2.3 L).
Lower oil capacity 4.4 pt (2.1 L).

SAE 80W-90 check every 25-30hrs.

SP & SP2 Models

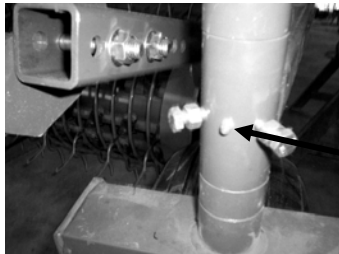
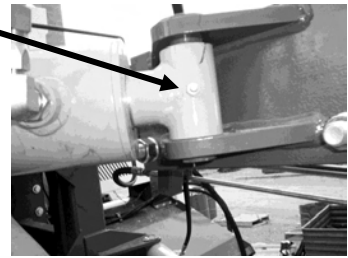

Main wheel hub & bearings. One
lube site for each wheel. Lube
every 40-50 hrs.

Front gauge wheels lube each
wheel every 8-10 hrs.

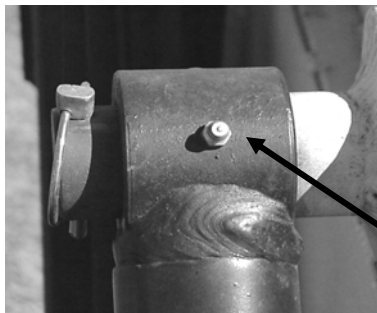
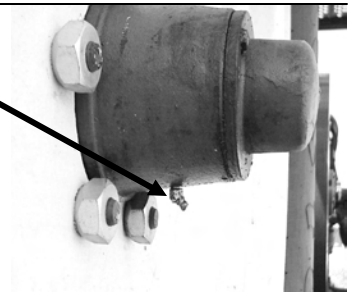

Radial pin clutch, lube only when clutch
has been releasing during normal
operation. If clutch seldom releases,
only minimum lube is required

Hydraulic lift cylinder hinge points &
dump bin pivot points Lubricate
every 8-10 hrs.

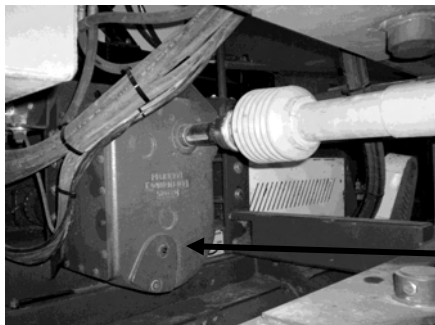
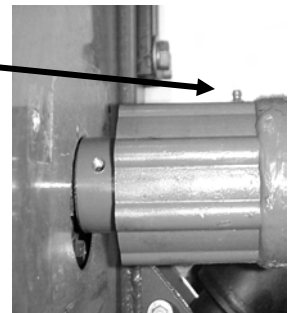

Check daily
Synthetic SAE 75W-90.

2 speed transmission sight
level gauge.
Oil capacity 8.5 pt (4 L)

Transporting

 **The vertical force exerted or tongue weight of 1,950 lb (886 Kg) is transferred to the drawbar of the tractor.**

The tongue weight in addition to the total weight of the combine will decrease the tractor's stability and maneuverability. Please use caution and allow for additional distance when braking or maneuvering around obstacles.

Do not transport the combine over 15 MPH (32 km/hr).

Make sure all reflectors, hazard lights and lamps are in working order.

Make sure the Slow Moving Vehicle emblem is clean and visible from the rear of the machine.

Be aware of other traffic on the road. Keep well over to your side of the road. Pull over, whenever you can, to allow faster traffic to pass.

Adjust travel speed to maintain control of the tractor and combine at all times. Never coast down hills.

Know the overall width and length of the machine. Be careful when transporting the machine on narrow roads and across bridges.

Never transport the machine on a roadway with crop in the tank.

Transporting combine on a trailer

Caution: When transporting the machine on a road or highway at night or during the day, use accessory light and devices for adequate warning to other vehicles. Check local governmental regulations. Keep safety items in good condition. Replace missing or damaged items.

Empty the holding tank and make sure it is in the lowered position.

To reduce the overall height, loosen the bucket elevator chain and disconnect chain at the connecting link. Tie a short piece of rope to the ends of the elevator chain to aid in reassembly. Remove the bolts at the splice in the elevator leg and fold the top part down in a rearward direction.

Lower tire pressure or remove the tires to achieve the proper height limitation. Rest the pull tongue on the trailer floor, and put adequate blocks under the chassis frame of the combine for stability. Chain and secure the combine tightly to the trailer. The outer chute or lip of the bin can be removed to reduce overall width and height. Make sure all loose items are securely fastened to the trailer.

Tire Specifications



Tire size-18.4 x 30
Maintain 20 lbs. (140 kPa)
pressure



Pickup head tire
Tire size-18 x 9.5-8
Maintain 24 lbs. (165 kPa)
pressure

Storage & Winterizing

- Clean combine of all crop residue.
- Empty all crop from bin.
- Lubricate all grease fittings.
- Service and lube the primary & secondary drivelines as per Walterscheid specs.
- Check tires for proper inflation.
- Fold elevator leg over, if necessary for storage.



TROUBLE SHOOTING - Problems (P) / Solutions (S)

P. Hydraulic oil is overheating.

S. Excessive oil flow. The oil to pickup head, feeder house, shaker table, bucket elevator, cross auger, and leveling auger in bin are operated in series by one remote. Do not use more oil than required. Open shaker table flow control on the motor to full ON (counter clockwise). Regulate the flow of hydraulic oil from the tractor until shaft speed on shaker is approximately 340 RPM then set the speed to 325-330 RPM using the flow control on the shaker motor. There will be plenty of oil to operate rest of machine.

S. Check hydraulic oil level in tractor. Check hydraulic filters on tractor. Check for blocked oil cooler on tractor.

P. Pickup head stops and will not turn.

S. Check all chains and sprockets for tightness and alignment.

S. Check touch screen monitor and make sure the pickup head speed control is turned up and on.

S. Check cam arms on pickup head for proper tracking in the cam.

S. Check the cam bearings for wear.

S. Check fuses.

S. Check that 12 Volt power supply is properly connected and has a good ground.

S. Check to see electrical receptacle for the solenoid on aluminum valve block is connected properly, clean and reconnect.

S. Check for any obstruction in pickup head.

P. Shaker table not working properly.

S. Check all fasteners for tightness on eccentric shaker arm and bearing assembly.

S. Check shaker pan springs that support shaker table. Make sure they are not bent or broken and replace when necessary.

P. Picking up rock with pickup head.

S. Slow pickup head down to 1/2 of ground speed, approximately 30 to 35 RPM.

S. Operate pickup head teeth 1/2" to 2" (12 to 50 mm) above soil surface. Use adjustable gauge wheels to maintain proper height.

S. Ensure that soft fingers (part # 106052) are being used.

P. Pickup head not picking up windrow.

S. Check for broken chain/hydraulic motor.

S. Replace broken teeth.

S. Lower pickup head until pickup head teeth are 1/2" to 1" (12 to 25 mm) above

ground surface.

S. Check cam bearings and finger tube bolts.

P. Broken Teeth.

S. Running pickup head too low.

S. Check for damaged rotor rods rubbing fingers.

P. Transition auger plugging.

S. Slow down and reduce crop feeding into machine.

S. Check for bent auger flighting or worn paddles.

P. Splits or cracks in beans.

S. Slow down cylinder by reducing RPM on tractor or change speed at transmission to low gear. Remember when slowing down cylinder, vacuum will require adjustment accordingly.

S. Inspect threshing cylinder and make sure the pins are not too close to the concave. Pins are normally at the bottom of the pin pocket with a minimum of 1/2" to 3/4" (12 to 19 mm) clearance between the pin and the concave.

S. Stop the combine abruptly while threshing. Remove inspection plates on the sides of the combine and inspect product on the shaker table for splits and damage and location of damage. The threshing cylinder may not be the only place to look for damage. Bucket elevator, bucket elevator auger or shaker table may not be operating at the correct speed and causing the damage. Once the problem area has been found make proper adjustments to eliminate damage.

P. Production capacity loss.

S. Threshing pins may be set to aggressively slowing the threshing process. Return to start up pin setting.

S. Check for bent, worn or damaged auger flighting on main cylinder. Straighten or repair as needed.

S. Check for bent, worn or damaged auger flighting or paddles on the transition auger. Repair as needed.

P. Pickup head stalling.

S. Check all fasteners throughout pickup head and make sure they are tight and positioned correctly.

S. Check drive chain and sprockets for proper tension and alignment.

S. Check for foliage lodged between the round roller and platform frame.

P. Dirt in beans.

S. Slow pickup head down, if the pickup head speed is too fast dirt is not allowed time to fall to the ground.

S. Pickup head operating too low, with teeth digging in the dirt. Lower gauge wheels to bring teeth up.

S. Adjust cutting & windrowing system to eliminate dirt before it gets to the combine.

S. Inspect vacuum fan. Listen, and feel combine for unusual vibration. Clean fan blade when buildup occurs.

S. If dirt is from small dirt clods use a smaller final screen. Ensure the bumper bar is correctly adjusted.

P. Monitor not functioning properly.

S. Check all electrical connections and wiring. Check 12-Volt power source. Check entire system for damage.

S. Check fuses.

S. Make sure sensors are the proper distance from the sprockets.

P. Transition auger plugged.

S. The right side of the auger will accept a tool that is provided with the combine to reverse the auger, aiding in the unplugging process.

S. Check for mechanical failures such as a seized bearing, misaligned sprockets and chain or faulty radial pin clutch.

S. Check the transition auger for bent, worn or damaged auger flighting or paddles.

P. Trash in bin with beans.

S. Adjust vacuum.

S. Check condition of fan and shroud.

S. Check belt tension on the vacuum fan.

S. Check cylinder pin setting.

S. Check final screen size.

P. Plugged elevator.

S. Conditions are too wet.

S. Bearing seized or worn out.

S. Bucket elevator chain loose and lodged or caught.

P. Leaving beans on ground from windrow.

S. Pickup head operating too high off the ground. (If leaving whole plants).

S. Pickup head operating at too fast of RPM.

S. Pickup head operating too low, finger is bending in the dirt then hitting the crop

with enough force to thresh the plant on the ground.

S. Tractor tires running over the windrow.

P. Leaving beans on ground behind the combine mostly cracked.

S. Too much vacuum suction, adjust suction.

S. Shaker pan speed to fast causing crop to bounce.

P. Leaving beans on ground from final screen.

S. Final screen out of adjustment.

S. Final screen to small for seed size.

S. Holes in final screen plugged with debris.

S. Damage to shaker pan or belting seal around the shaker pan.

S. Rate of travel to fast for combine capacity.

P. Leaving beans on ground behind the combine unthreshed and mixed with straw.

S. Cylinder pin setting may need to be more aggressive.

S. Cylinder RPM may need to be changed to a faster speed.

S. Threshing pins may be worn out, keep threshing pins in good condition.

P. Leaving beans on ground behind the combine threshed but mixed with straw.

S. Cylinder pin setting may need to be more aggressive.

S. Set a pin near the rear of the cylinder to an extreme hard thresh or 2:00 forward setting, then the next pin to the extreme easy thresh or 10:00 rearward setting. Repeat this pattern two to four times. This will tear the foliage apart and let the crop find the holes in the concave.

S. If holes in concave are covered with a mat of grass or foliage set a few pins near the rear of the concave close to the concave and pointing to the rear of the combine to help sweep the material off of the concave.

S. Cylinder RPM may need to be changed to a faster speed.

S. Replacing two threshing pins with knives (usually pins # 1 and # 4) will help brake the foliage into smaller pieces and allow the crop to more easily find the concave holes. Remove the pin and place the knife on the same side of the flighting as the pin was. Use a 9/16" (14 mm) spacer so the knife cuts straight through the material.

Average Threshing Cylinder and Fan Speeds

With 540 / 390 Transmission

Transmission in high gear and large (5.4) sheave on fan – mechanical straw chopper drive small to large (4.8 to 5.4)

<u>Tractor</u> <u>Speed</u>	<u>PTO</u> <u>Speed</u>	<u>Cylinder</u> <u>Speed</u>	<u>Fan</u> <u>Speed</u>	<u>Chopper</u> <u>Speed</u>
2100	1000	540	1840	1840
1950	929	502	1707	1707
1800	857	463	1575	1575

Transmission in low gear and small (4.8) sheave on fan – mechanical straw chopper drive large to small (5.4 to 4.8)

<u>Tractor</u> <u>Speed</u>	<u>PTO</u> <u>Speed</u>	<u>Cylinder</u> <u>Speed</u>	<u>Fan</u> <u>Speed</u>	<u>Chopper</u> <u>Speed</u>
2100	1000	392	1503	1690
1950	929	364	1396	1570
1800	857	336	1289	1450

With 500 / 350 Transmission

Transmission in high gear and large (5.4) sheave on fan – mechanical straw chopper drive small to large (4.8 to 5.4)

<u>Tractor</u> <u>Speed</u>	<u>PTO</u> <u>Speed</u>	<u>Cylinder</u> <u>Speed</u>	<u>Fan</u> <u>Speed</u>	<u>Chopper</u> <u>Speed</u>
2100	1000	500	1704	1704
1950	929	464	1579	1579
1800	857	429	1457	1457

Transmission in low gear and small (4.0) sheave on fan – mechanical straw chopper drive large to small (5.4 to 4.8)

<u>Tractor</u> <u>Speed</u>	<u>PTO</u> <u>Speed</u>	<u>Cylinder</u> <u>Speed</u>	<u>Fan</u> <u>Speed</u>	<u>Chopper</u> <u>Speed</u>
2100	1000	347	1596	1496
1950	929	323	1484	1392
1800	857	298	1370	1285

Specifications

Pull Type Combine

	<u>Straight Pull</u>	<u>SP2</u>
Total working height	15' 2" (4.6 M)	15' 2" (4.6 M)
Total working width	12' 5" (3.8 M)	13' 9" (4.2 M)
Shipping width		
With head installed	11' 11" (3.6 M)	13' 3" (4 M)
With head removed	11' 4" (3.5 M)	11' 4" (3.5 M)
Bin removed head on	10' 3" (3.1 M)	11' 9" (3.6 M)
Shipping height		
With bin	11' 7" (3.5 M)	11' 7" (3.5 M)
Bin removed	9' 10" (3 M)	9' 10" (3 M)
Total length	24' 5" (7.4 M)	32' 6" (9.9 M)
Weight	10,604 lbs. (4,820 Kg)	11,848 lbs. (5,385 Kg)
Bin capacity	8,800 lbs. (4,000 Kg)	8,800 lbs. (4,000 Kg)
Tongue weight	1,250 lbs. (568 Kg)	1950 lbs. (886 Kg)
Usable pickup head width	84" (2.1 M)	120" (3 M)
Dump height	12' at pivot pin (3.7 M)	12' at pivot pin (3.7 M)
Tire size	18.4 – 30	18.4 – 30
Tractor requirements	125 PTO HP min. 150+ PTO Hp preferred 3 hydraulic remotes 1 3/4" 20 spline or 1 3/8" 21 spline 1000 RPM PTO	125 PTO HP min. 150+ PTO Hp preferred 4 hydraulic remotes 1 3/4" 20 spline or 1 3/8" 21 spline 1000 RPM PTO

Machine Identification

For parts and service please have the following information:

- ◇ Model Year
- ◇ Serial Number



Refer to machine ID tag

Hydraulic Hose Specifications

Hose Inside Diameter	Hose Outside Diameter	Maximum Working Pressure	Minimum Burst Pressure	Minimum Bend Radius	Operating Temperature Range
3/8" (9.5mm)	3/4" (18mm)	4775 psi (330 bar)	21200 psi (1464 bar)	2 1/2" (63.5mm)	-50°F to 260°F
1/2" (12.7mm)	7/8" (21.6mm)	4000 psi (275 bar)	18000 psi (1240 bar)	3 1/2" (89mm)	
3/4" (19mm)	1 1/8" (38mm)	3120 psi (215 bar)	14000 psi (964 bar)	4 3/4" (120mm)	(-46°C to 126°C)

Hoses should be inspected daily. Any hose where the outer cover is swollen, torn, frayed or shows fiscal damage in any way must be replaced. Look closely for small cracks in the outer cover these will also need to be replaced. Check to make sure that hoses are tied securely and can not come into contact with moving parts that can cause damage. Check the routing of the hoses to ensure there are no sharp bends that can cause damage.

Always maintain a full hydraulic oil level in the tractor. Check tractor for hydraulic leaks. Maintain hydraulic oil filter according to tractor manufacture's recommendations.

-  **Make your inspections and repairs with the tractor off and the keys removed.**
-  **Always wear your personal protective equipment while making your inspections and maintaining hoses. Avoid high pressure fluids by relieving the pressure in the hoses before making repairs. Escaping fluid under pressure can penetrate the skin causing serious injury.**
-  **If a hose needs to be replaced dispose of old hose and any fluid lost from the machine properly. Follow local guidelines for proper waste disposal.**



Pickett Equipment

976 East Main Street * Phone: 208-678-0855 * www.pickettequipment.com
Burley, Idaho 83318 * Fax: 208-678-1404 * pickett@rvmi.com