

One Step Rod Cutter Rear Pull

Drivelines

Section 13

Model Years 1988 – 1991 (Secondary Driveline) 1" Solid Shaft.....	2-5
Model Years 1988 – 1992 (Primary Driveline) G & G	6-11
Model Year 1992 (Secondary Driveline) G & G	12-13
Model Year 1993 (Primary Driveline) Walterscheid	14-19
Model Year 1993 (Secondary Driveline) Walterscheid	20-21
Model Years 1994 – Present (Primary Driveline) Walterscheid.....	22-27
Model Years 1994 – Present (Secondary Driveline) Walterscheid	28-29

Return to this page by clicking the upper right corner of any page in this section.

DETAILED VIEW OF ITEM NO.69

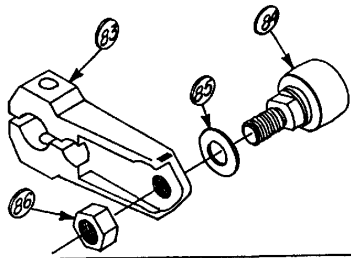

DETAILED VIEW OF PTO GEAR BOX

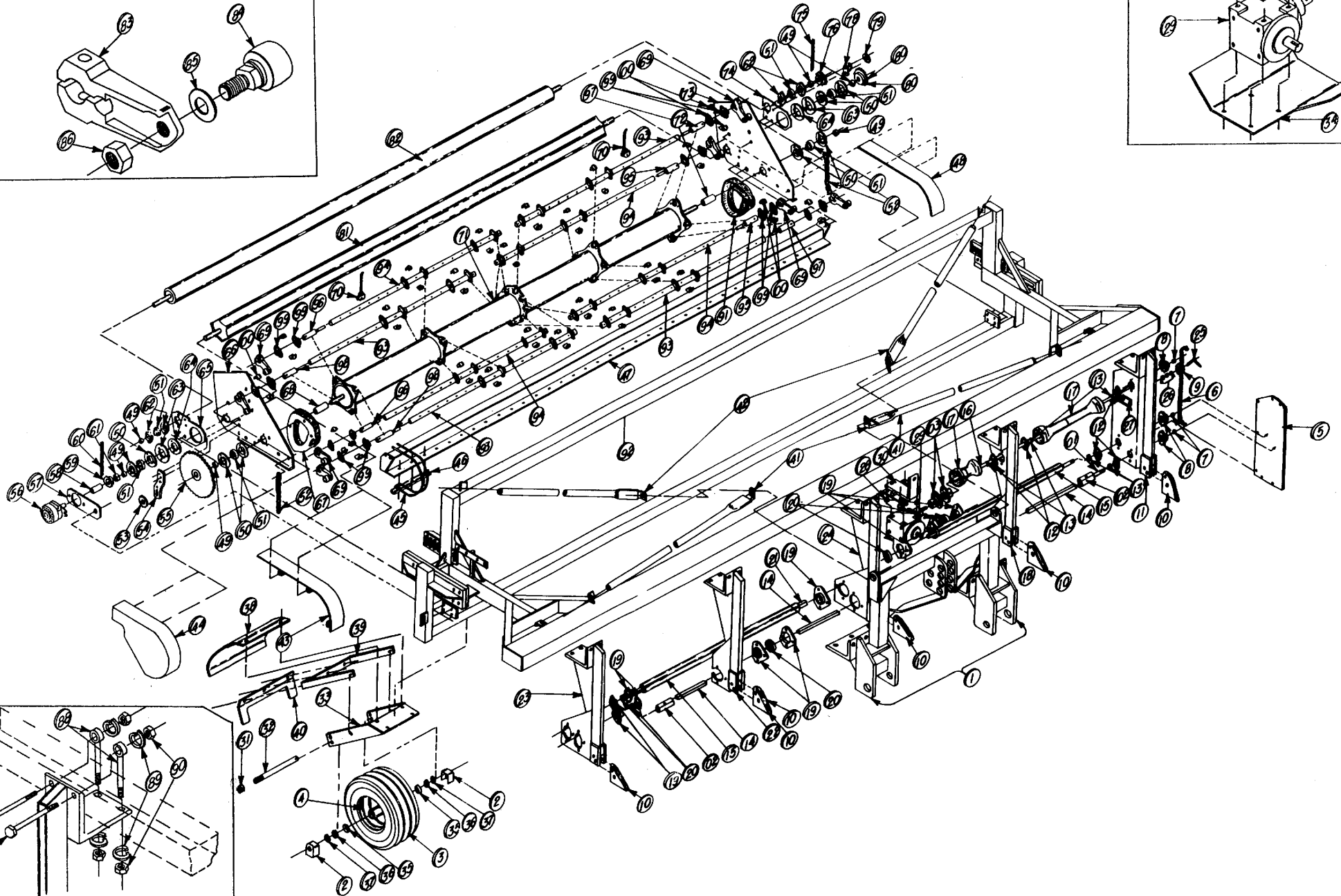
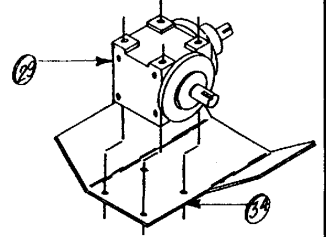

TYPICAL MOUNTING HARDWARE FOR 6x4 TOOL BAR

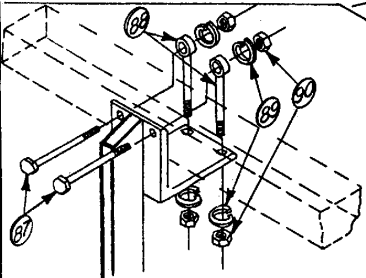

ONE STEP PARTS LIST (1991)

Parts List

<u>Item No.</u>	<u>Obsolete No.</u>	<u>Order No.</u>	<u>Description</u>
1.	800000	800000★	Three Point Hitch
Not Shown	800100	116001	Three Point Pin
2.	900243	990173	Wheel Guard
3.	18 × 9.5-8	120000	Tire
4.	101148-4600	123000	Steel Wheel (obsolete, requires kit # 405020)
6.	CO6036	103013	Chain, #60 Roller 36
8.	SP60BS12	119014	Sprocket Chain Case
9.	G160-13	119017	Sprocket Idler
10.	900372	116006	Point, Shear
Not Shown	116007	116023	Point, Rock
11.	900403★	900565	Left Hand Chain Case(♦ See Note)
12.	P3Y216E3	102016	Bearing 2 Hole Flange
14.		900461-82291	1" Cutter Rod 8-2291
		900461-63091	1" Cutter Rod 9-3091
15.	900027	900027	Kicker Tube 83" Drive
	900026	900026	Kicker Tube 85" End (900026 & 900027 Used on 8 row 22")
	900028	900028	Kicker 55½" Drive
	900029	900029	Kicker 57½" Center
	900030	900030	Kicker 57½" End (900028, 900029, 900030 Used on 6 row 30")
16.	900182	900182	PTO Drive Shaft 74½" 8-22
	900182	900182	PTO Drive Shaft 80" 6-30
17.	303-1248	103031	PTO Plastic Cover
18.	900406★	900585	Shank 1 Hole with Drive Hole(♦ See Note)
19.	F80-MS	106007	Flangett Housing
20.	0208-TT6	102000	Bearing 1" Square
21.	900032	900032	Kicker Key 7"
22.	900407	900407	Shank 1 Hole without PTO
23.	900408	900405	Shank End 2 Hole without PTO
24.	900405	900405	Shank Center 2 Hole without PTO
25.	900033	900033	Idler Sprocket Bolt

Conversion Kits available for this machine (See Service Update Section)

<u>Kit No.</u>	<u>Description</u>	<u>Kit No.</u>	<u>Description</u>
405022	Gauge Wheel Conversion Kit (converts model '91 to '93)	900800-822	Chain Case Update (8 row 22")
		900800-630	Chain Case Update (6 row 30")
900754	Center Dump Table Kit★ (converts model '91 to '93)	901246	Pick Up Head Conversion Kit
900755	Semi-end Table Kit★ (converts model '91 to '93)	Obsolete No. 940003	(6 row 30" & 8 row 22")
		405020	Small Wheel Conversion Kit

ONE STEP PARTS LIST (1991)

Parts List

<u>Item No.</u>	<u>Obsolete No.</u>	<u>Order No.</u>	<u>Description</u>
27.	900170	900170	Idler Sprocket Plate
28.	900181	900181	PTO Spacer
29.	A101-E	107001	Gear Box Left Hand
30.	900180	900180★	Gear Box Mount (can be updated)
32.	215-209	990080	Axle
33.	900249	900249★	Wheel Mount
34.	900254	900254★	PTO Shield (can be updated)
35.	L44610	102002	Bearing Race
36.	L44643	102001	Wheel Bearing
37.	204029	119024	Bearing Seal
38.	900247	900247★	Fender
39.	900252	900252★	Scraper Bracket
40.	900210	900210★	Mud Scraper
41.	900335	900335★	Guy Rod Front
42.	900336	900336★	Guy Rod Rear
43.	900414	900414	Shroud Right Hand
44.	900316	900316	Chain Guard 50 Chain
45.	504-68-2	118015	Rotor Rod
46.	118-3	103023	Clip Rotor Rod 3 Hole
47.	900203	900203	Rotor Rod Mount
48.	900413	900413	Shroud Left Hand
50.	52 MS	106004	Flangett 3 Hole
51.	202-20	102005	Bearing 1" Insert with Lock Collar
52.		103039	Chain Pickup Head
53.	SP50BS13	119010	Sprocket Idler
54.	20-2879	900334	Idler Sprocket Mount
55.	SP50BS60	119008	Sprocket Pickup Tube
56.	110A001-ASO 110A-071-ASO	113023	Hydraulic Pickup Motor
57.	609010	900225	Hydraulic Motor Mount
58.	P-100-100	103017	Coupler 1" × 1" × 3" Split
59.	SP50BS15	119006	Sprocket Hex Tube R.H.
60.	237-60	103012	Chain #50 Roller 39
62.	F52-MST	106013	Flangett 2 Hole
63.	733-30	900571	Hinge Lock
64.	313-410	900570	Hinge Spacer
65.	20-1907	900572	Hinge Bracket R.H. } Replaced by 900573
66.	900010-4	900019-R	Mounting End Plate R.H.
67.	461-41	103001	Cam Track R.H.
68.	900377	900377	Spacer Rotor R.H.

ONE STEP PARTS LIST (1991)

Parts List

<u>Item No.</u>	<u>Obsolete No.</u>	<u>Order No.</u>	<u>Description</u>
69.	900281-A	103044	Cam Arm
70.	504-67	106000	Finger Rubber
71.	900400	900400★	Pickup Tube Assembly
72.	900378	900378	Spacer Rotor L.H.
73.	900019-4	900019-L	Mounting End Plate L.H.
74.	20-19075	900573	Hinge Bracket L.H. Slotted
75.	CO4038	103007	Chain #40 Roller
76.	SP40BS15	119004	Sprocket 4" Roller
78.	900137	900137	Idler Sprocket Mount
79.	SP4017	119005	Sprocket Idler
80.	SP40BS26	119003	Sprocket Hex Roller
81.	900401	900401	Hex Roller
82.	900402	900402	Roller 4"
84.	200-107	102015	Bearing Cam
87.	7509-G8	106009	Bolt $\frac{3}{4}$ " x 9"
88.	REC-197	118000	Rod End
91.	461-40	103000	Cam Track L.H.
93.	900360	900360	Finger Rod 86 $\frac{3}{4}$ "
94.	900359	900359	Finger Rod 84 $\frac{3}{4}$ "
95.	900275L	119068	Shaft Plug Finger Rod
96.	900275R	119069	Shaft Plug Finger Rod
97.	900276L	119070	Shaft Plug Finger Rod
98.	900276R	119071	Shaft Plug Finger Rod
99.	40 MST	106002	Flangett Two Hole
00.	900333	102034	Plastic Bushing End
Not Shown	900333-S	102035	Plastic Bushing Center
01.	900211	900211	Stub Shaft
02.	900373	900373	Cutter Rod Coupler
03.	999-2000	103025	Clutch, Shear (PTO)

★ Also used in conjunction with kit no. 405022 to convert model '91 to '93

◆ To use shank No.'s 900565 and 900585, contact Pickett Equipment or your local dealer for conversion update information.

★ This part is manufactured on a built-to-order basis only. Call Pickett Equipment for availability and lead time.

104003

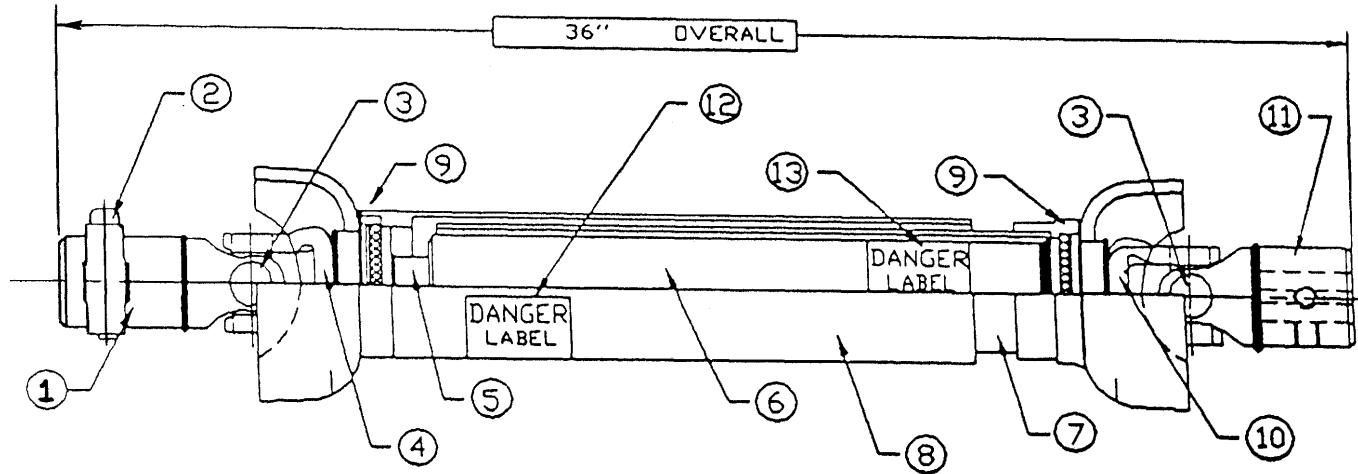

**MODEL 92 PTO GEAR BOX
TO TRACTOR DRIVELINE**

**PART NO.
104003**

**PTO GEAR BOX TO TRACTOR DRIVELINE, Primary (1988–1992)
#104003 (G&G)****Parts List**

<u>Item No.</u>	<u>Part No.</u>	<u>Qty</u>	<u>Description</u>
1.	125005	1	Yoke, Snap Hitch 1 ³ / ₈ "—6 Spline
2.	125006	1	Yoke, Snap Hitch Kit
3.	103030	2	Bearing Cross
4.	125007	1	Yoke, Inner Sliding Member
5.	104025	1	Driveline, Inner Sliding Member
6.	104026	1	Driveline, Outer Sliding Member
7.	119030	1	Shield, Driveline—Includes Item # 8
8.	See Item No. 7		
9.	102030	2	Bearing, Driveline Shield Kit
10.	125008	1	Yoke, Outer Sliding Member
11.	125004	1	Yoke, 1 ¹ / ₄ " KW—SS Round Bore
12.	112005	1	Label, Outer Danger
13.	112012	1	Label, Inner Danger

104004

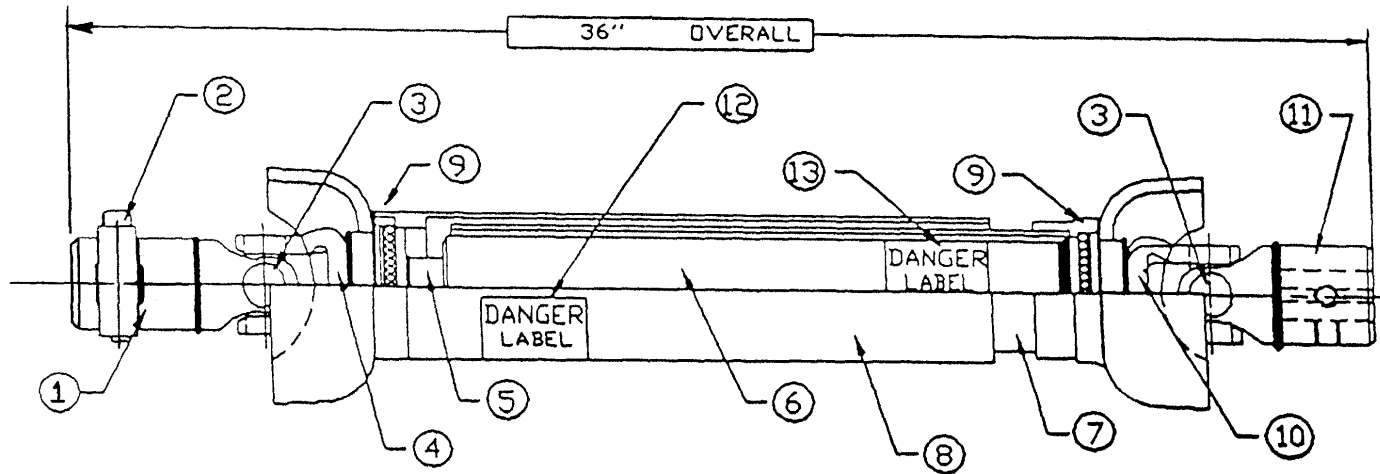

**MODEL 92 PTO GEAR BOX
TO TRACTOR DRIVELINE**

**PART NO.
104004**

PTO GEAR BOX TO TRACTOR DRIVELINE, Primary (1988–1992) #104004 (G&G)

Parts List

<u>Item No.</u>	<u>Part No.</u>	<u>Qty</u>	<u>Description</u>
1.	125000	1	Yoke, Snap Hitch 1 ³ / ₄ "—20 Spline
2.	125006	1	Yoke, Snap Hitch Kit
3.	102068	2	Bearing Cross, 1 ³ / ₄ "—20 Spline
4.	124009	1	Yoke, Inner Sliding Member
5.	104025	1	Driveline, Inner Sliding Member
6.	104026	1	Driveline, Outer Sliding Member
7.	119111	1	Shield, Driveline—Includes Item # 8
8.	See Item No. 7		
9.	102030	2	Bearing, Driveline Shield Kit
10.	124010	1	Yoke, Outer Sliding Member (Requires Special Order)
11.	125011	1	Yoke, 1 ¹ / ₄ " Round Bore, 1 ¹ / ₈ " KW, 3 ³ / ₈ " SS
12.	112005	1	Label, Outer Danger
13.	112012	1	Label, Inner Danger

104005

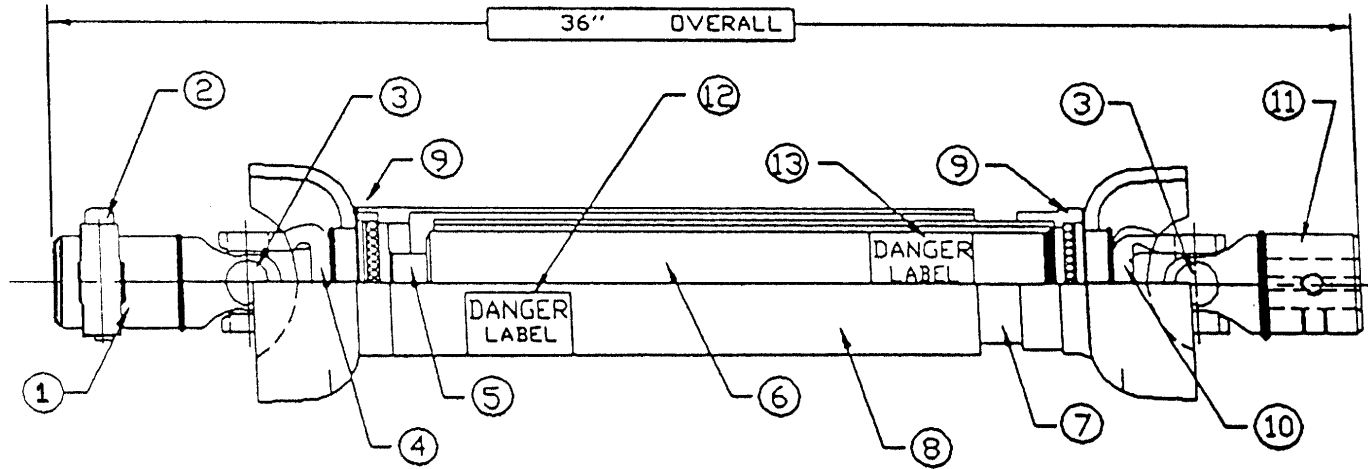

**MODEL 92 PTO GEAR BOX
TO TRACTOR DRIVELINE**

PTO GEAR BOX TO TRACTOR DRIVELINE, Primary (1988–1992) #104005 (G&G)

Parts List

<u>Item No.</u>	<u>Part No.</u>	<u>Qty</u>	<u>Description</u>
1.	125003	1	Yoke, Snap Hitch 1 ³ / ₈ "—21 Spline
2.	125006	1	Yoke, Snap Hitch Kit
3.	103030	2	Bearing Cross
4.	125087	1	Yoke, Inner Sliding Member
5.	104025	1	Driveline, Inner Sliding Member
6.	104026	1	Driveline, Outer Sliding Member
7.	119030	1	Shield, Driveline—Includes Item # 8
8.	See Item No. 7		
9.	102030	2	Bearing, Driveline Shield Kit
10.	125008	1	Yoke, Outer Sliding Member (Requires Special Order)
11.	125004	1	Yoke, 1 " KW—SS Round Bore
12.	112005	1	Label, Outer Danger
13.	112012	1	Label, Inner Danger

104006

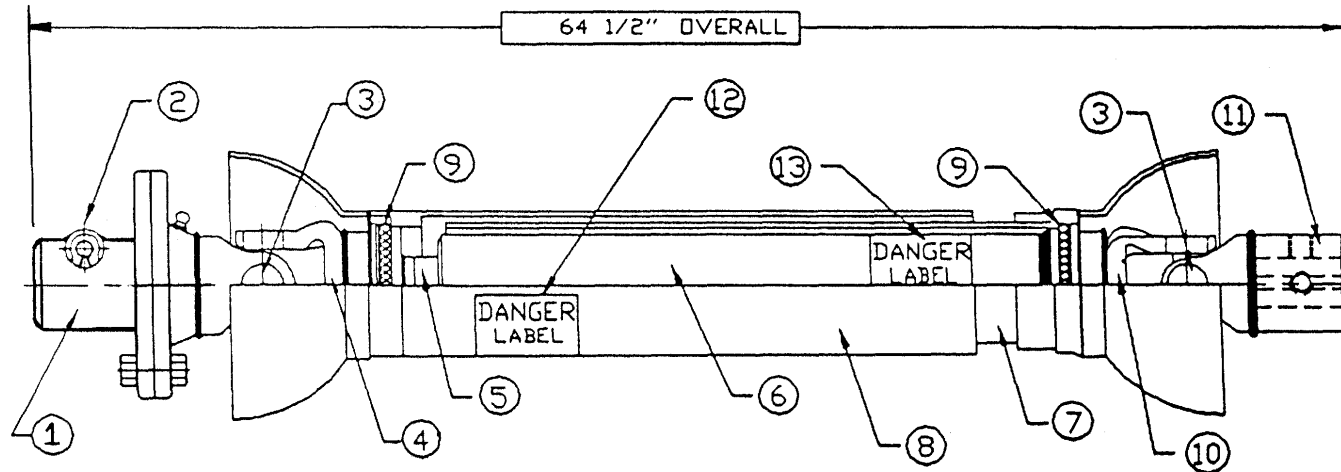

**MODEL 92 PTO GEAR BOX
TO CHAIN CASE DRIVELINE**

PTO GEAR BOX TO CHAIN CASE DRIVELINE, Secondary (1992) #104006 (G&G)

Parts List

<u>Item No.</u>	<u>Part No.</u>	<u>Qty</u>	<u>Description</u>
1.	125001	1	Yoke, Snap Hitch 1 ³ / ₈ "—6 Spline Shear Clutch
2.	125006	1	Yoke, Snap Hitch Kit
3.	103030	2	Bearing Cross
4.	125007	1	Yoke, Inner Sliding Member
5.	104025	1	Driveline, Inner Sliding Member
6.	104026	1	Driveline, Outer Sliding Member
7.	119112	1	Shield, Driveline—Includes Item # 8
8.	See Item No. 7		
9.	102030	2	Bearing, Driveline Shield Kit
10.	125008	1	Yoke, Outer Sliding Member (Requires Special Order)
11.	125004	1	Yoke, 1 ¹ / ₄ " KW—SS Round Bore
12.	112005	1	Label, Outer Danger
13.	112012	1	Label, Inner Danger

104003

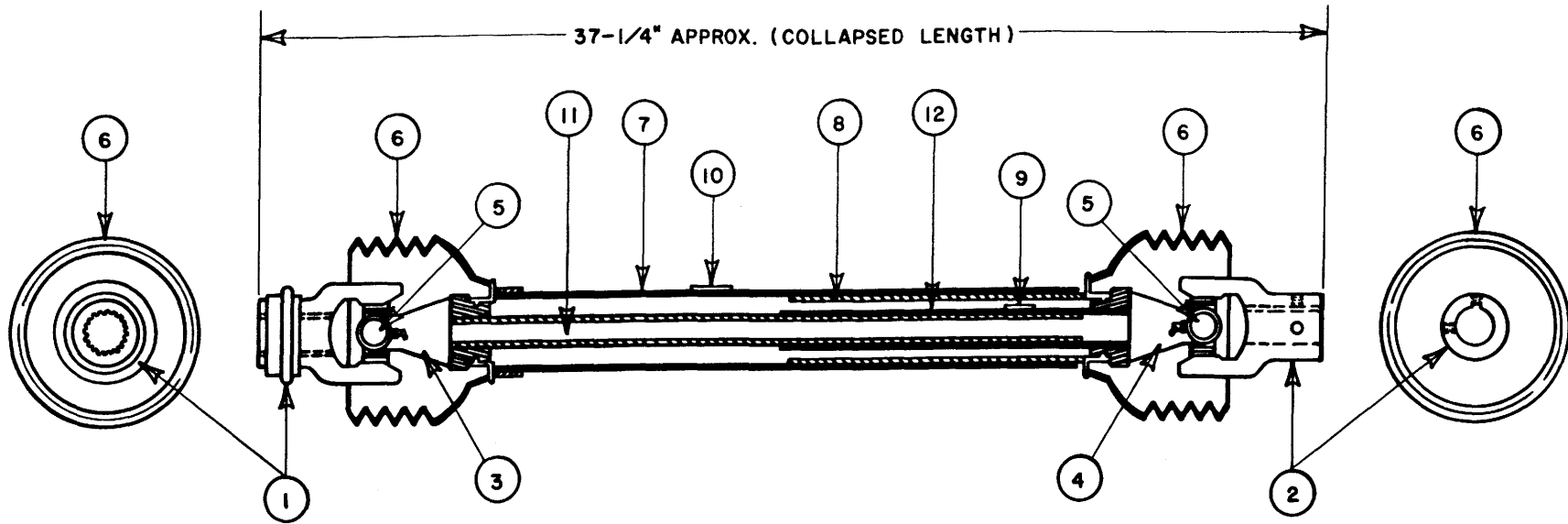

MODEL 93 PTO GEAR BOX
TO TRACTOR DRIVELINE

PART NO.
104003

**PTO GEAR BOX TO TRACTOR DRIVELINE, Primary (1993)
#104003 (Walterscheid)****Parts List**

<u>Item No.</u>	<u>Part No.</u>	<u>Qty</u>	<u>Description</u>
1.	124014	1	21 Spline Yoke, 1 ³ / ₈ "
2.	124001	1	1 ¹ / ₄ " Yoke (Round Base with Keyway)
3.	124007	1	Inboard Yoke
4.	124008	1	Inboard Yoke
5.	103078	2	U-Joint Cross Bearing
6.	119102	2	Shield Cone, 5 Rib
7.	119107	1	Outer Shield Tube
8.	119108	1	Inner Shield Tube
9.	104008	1	Decal, Inner Warning
10.	104007	1	Decal, Outer Warning
11.	104023	1	Inner Drive Sleeve
12.	104024	1	Outer Drive Sleeve
Not Shown	119115	2	Shield Cone, 12 Rib (Option)

104004

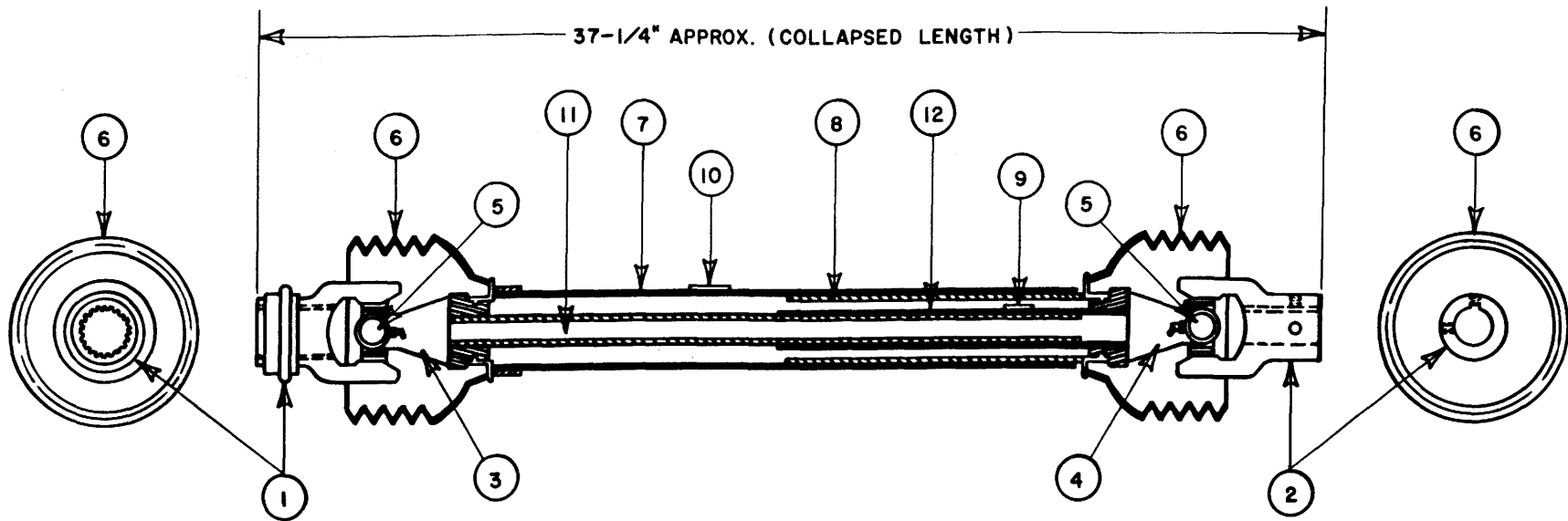

MODEL 93 PTO GEAR BOX
TO TRACTOR DRIVELINE

PART NO.
104004

**PTO GEAR BOX TO TRACTOR DRIVELINE, Primary (1993)
#104004 (Walterscheid)****Parts List**

<u>Item No.</u>	<u>Part No.</u>	<u>Qty</u>	<u>Description</u>
1.	124000	1	20 Spline Yoke, 1 ³ / ₄ "
2.	124001	1	1 ¹ / ₄ " Yoke (Round Base with Keyway)
3.	124007	1	Inboard Yoke
4.	124008	1	Inboard Yoke
5.	103078	2	U-Joint Cross Bearing
6.	119102	2	Shield Cone, 5 Rib
7.	119107	1	Outer Shield Tube
8.	119108	1	Inner Shield Tube
9.	104008	1	Decal, Inner Warning
10.	104007	1	Decal, Outer Warning
11.	104023	1	Inner Drive Sleeve
12.	104024	1	Outer Drive Sleeve
Not Shown	119115	2	Shield Cone, 12 Rib (Option)

104005

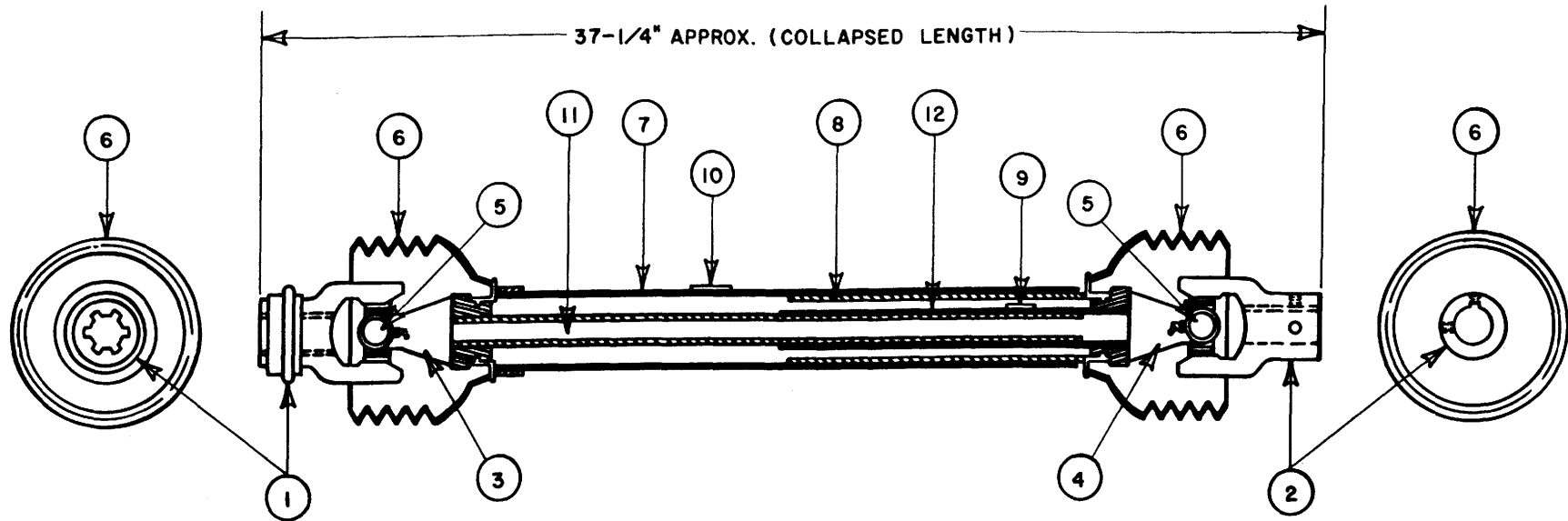

MODEL 93 PTO GEAR BOX
TO TRACTOR DRIVELINE

PART NO.
104005

**PTO GEAR BOX TO TRACTOR DRIVELINE, Primary (1993)
#104005 (Walterscheid)****Parts List**

<u>Item No.</u>	<u>Part No.</u>	<u>Qty</u>	<u>Description</u>
1.	124002	1	6 Spline Yoke, 1 ³ / ₈ "
2.	124001	1	1 ¹ / ₄ " Yoke (Round Base with Keyway)
3.	124007	1	Inboard Yoke
4.	124008	1	Inboard Yoke
5.	103078	2	U-Joint Cross Bearing
6.	119102	2	Shield Cone, 5 Rib
7.	119107	1	Outer Shield Tube
8.	119108	1	Inner Shield Tube
9.	104008	1	Decal, Inner Warning
10.	104007	1	Decal, Outer Warning
11.	104023	1	Inner Drive Sleeve
12.	104024	1	Outer Drive Sleeve
Not Shown	119115	2	Shield Cone, 12 Rib (Option)

104006

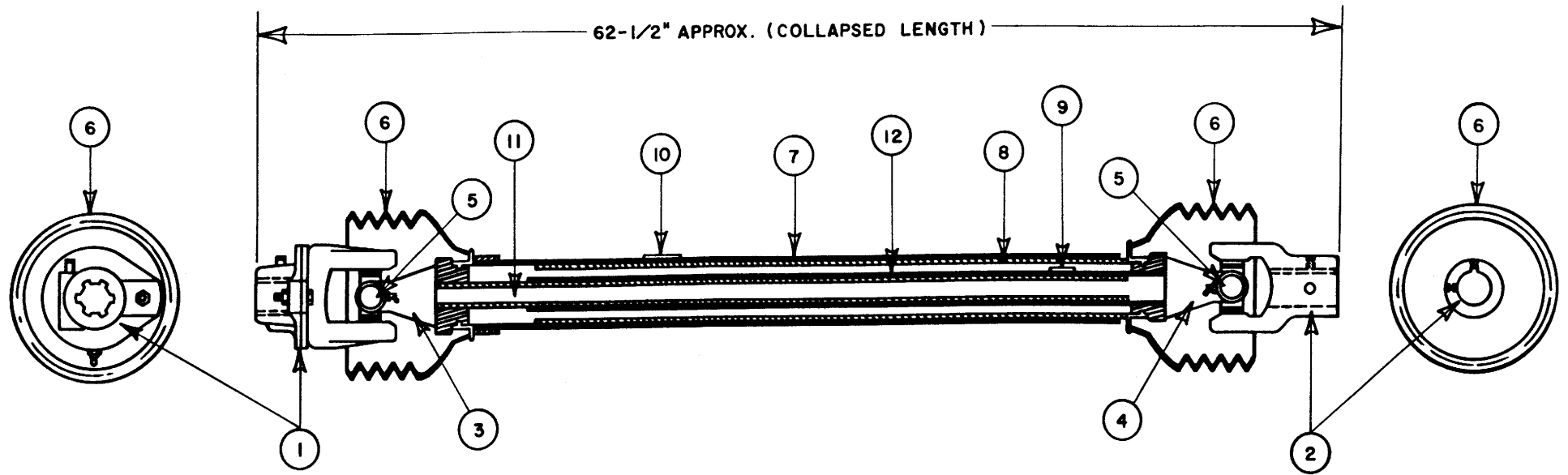

MODEL 93 PTO GEAR BOX
TO CHAIN CASE DRIVELINE

PART NO.
104006

**PTO GEAR BOX TO CHAIN CASE DRIVELINE, (1993)
(Walterscheid), Secondary, #104006****Parts List**

<u>Item No.</u>	<u>Part No.</u>	<u>Qty</u>	<u>Description</u>
1.	124006	1	Shear Clutch Yoke, 6 Spline
2.	124001	1	1¼" Yoke (Round Base with Keyway)
3.	124007	1	Inboard Yoke
4.	124008	1	Inboard Yoke
5.	103078	2	U-Joint Cross Bearing
6.	119102	2	Shield Cone, 5 Rib
7.	119103	1	Outer Shield Tube
8.	119104	1	Inner Shield Tube
9.	104008	1	Decal, Inner Warning
10.	104007	1	Decal, Outer Warning
11.	104021	1	Inner Drive Sleeve
12.	104022	1	Outer Drive Sleeve
Not Shown	119115	2	Shield Cone, 12 Rib (Option)

104009

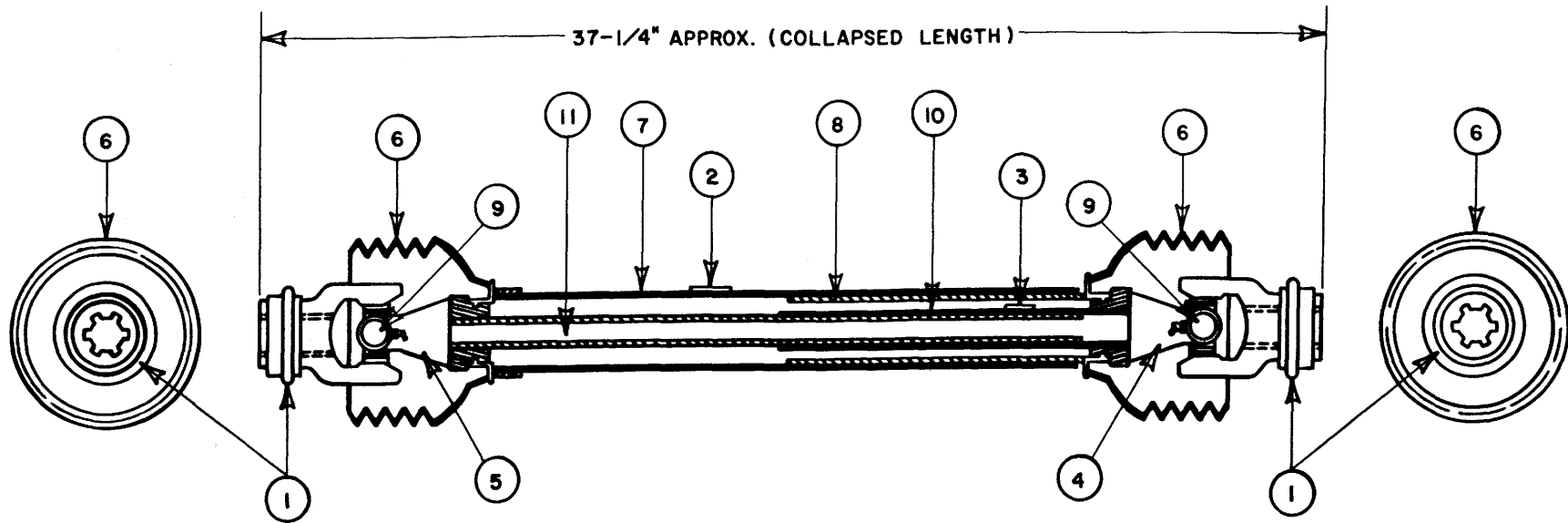

MODEL 94 PTO GEAR BOX
TO TRACTOR DRIVELINE

PART NO.
104009

PTO GEAR BOX—To Tractor Driveline, (1994–Present) (Walterscheid), Primary, #104009

Parts List

<u>Item No.</u>	<u>Part No.</u>	<u>Qty</u>	<u>Description</u>
1.	124002	2	6-Spline Yoke, 1 ³ / ₈ "
2.	112005	1	Decal, Outer Warning
3.	112012	1	Decal, Inner Warning
4.	124008	1	Inboard Yoke
5.	124007	1	Inboard Yoke
6.	119115	2	Shield Cone, 12 Rib
7.	119107	1	Outer Shield Tube
8.	119108	1	Inner Shield Tube
9.	103078	2	U-Joint Cross Bearing
10.	104024	1	Outer Drive Sleeve
11.	104023	1	Inner Drive Sleeve
Not Shown	102067	2	Bearing, Driveline Shield

104012

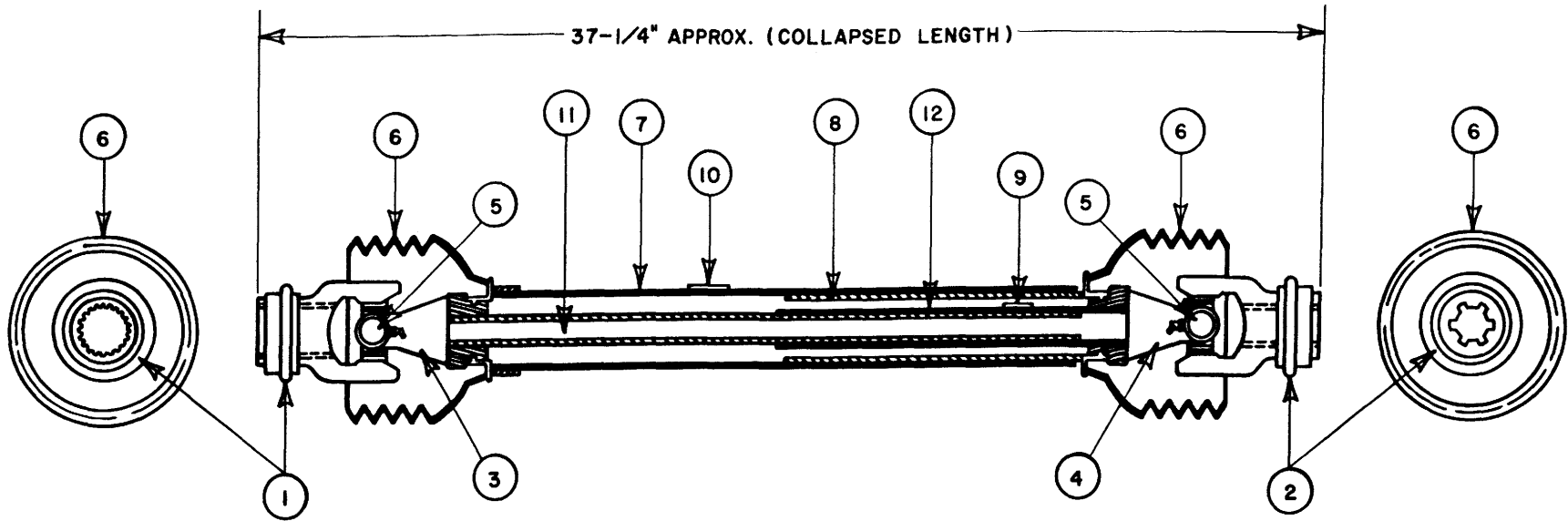

MODEL 94 PTO GEAR BOX
TO TRACTOR DRIVELINE

PART NO.
104012

PTO GEAR BOX—To Tractor Driveline, (1994–Present) (Walterscheid), Primary, #104012

Parts List

<u>Item No.</u>	<u>Part No.</u>	<u>Qty</u>	<u>Description</u>
1.	124014	1	21 Spline Yoke, 1 ³ / ₈ "
2.	124002	1	1 ³ / ₈ " Yoke, 6-Spline
3.	124007	1	Inboard Yoke
4.	124008	1	Inboard Yoke
5.	103078	2	U-Joint Cross Bearing
6.	119115	2	Shield Cone, 12 Rib
7.	119107	1	Outer Shield Tube
8.	119108	1	Inner Shield Tube
9.	112012	1	Decal, Inner Warning
10.	112005	1	Decal, Outer Warning
11.	104023	1	Inner Drive Sleeve
13.	104024	1	Outer Drive Sleeve
Not Shown	102067	2	Bearing, Driveline Shield

104013

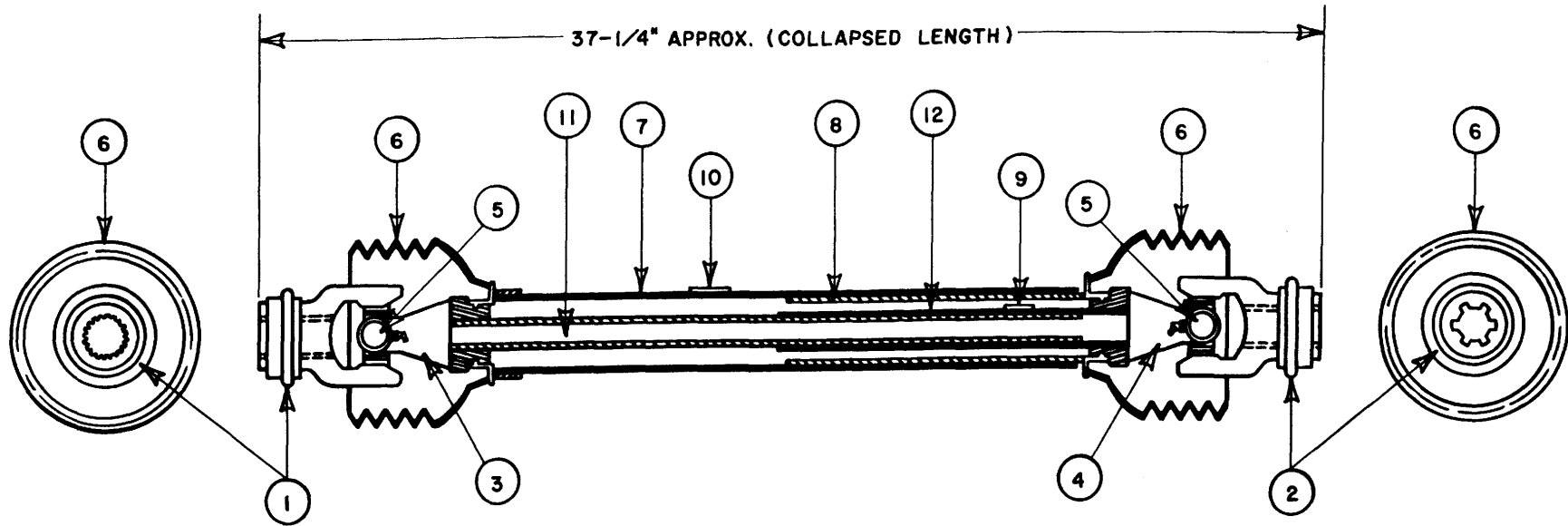

MODEL 94 PTO GEAR BOX
TO TRACTOR DRIVELINE

PART NO.
104013

PTO GEAR BOX—To Tractor Driveline, (1994–Present) (Walterscheid), Primary, #104013

Parts List

<u>Item No.</u>	<u>Part No.</u>	<u>Qty</u>	<u>Description</u>
1.	124000	1	20 Spline Yoke 1 $\frac{3}{4}$ "
2.	124002	1	1 $\frac{3}{8}$ " Yoke, 6-Spline
3.	124007	1	Inboard Yoke
4.	124008	1	Inboard Yoke
5.	103078	2	U-Joint Cross Bearing
6.	119115	2	Shield Cone, 12 Rib
7.	119107	1	Outer Shield Tube
8.	119108	1	Inner Shield Tube
9.	112012	1	Decal, Inner Warning
10.	112005	1	Decal, Outer Warning
11.	104023	1	Inner Drive Sleeve
12.	104024	1	Outer Drive Sleeve
Not Shown	102067	2	Bearing, Driveline Shield

104011

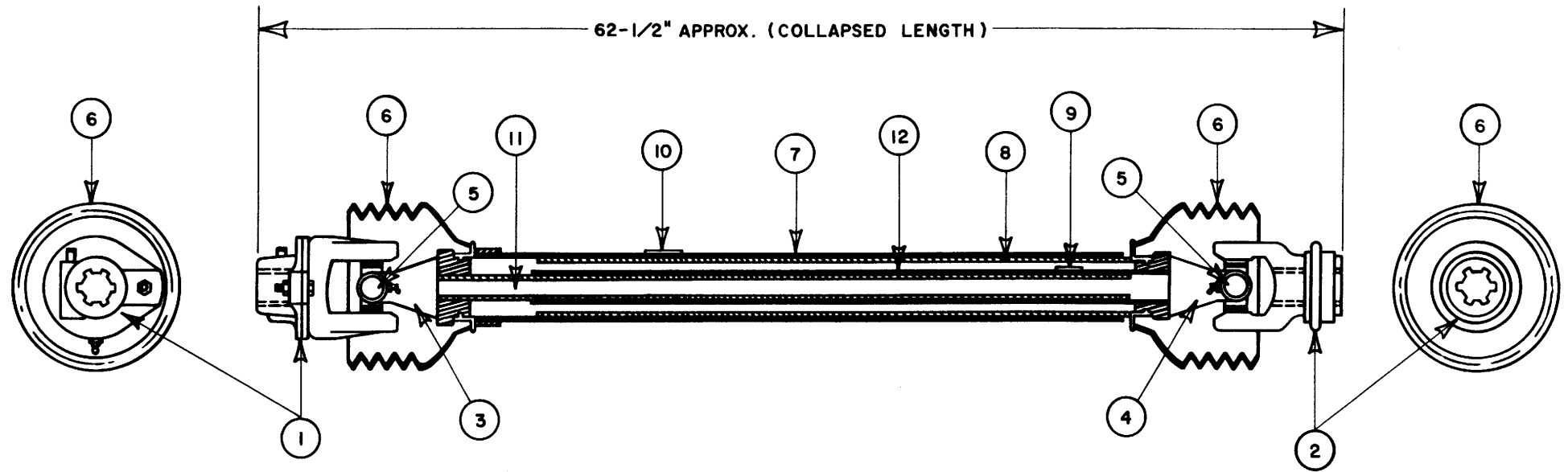

MODEL 94 PTO GEAR BOX
TO CHAIN CASE DRIVELINE

PTO GEAR BOX—To Chain Case Driveline, (1994–Present) (Walterscheid), Secondary, #104011 (full length)

Parts List

<u>Item No.</u>	<u>Part No.</u>	<u>Qty</u>	<u>Description</u>
1.	124006	1	Shear Clutch Yoke, 6-Spline
2.	124002	1	1 ³ / ₈ " Yoke, 6-Spline
3.	124007	1	Inboard Yoke
4.	124008	1	Inboard Yoke
5.	103078	2	U-Joint Cross Bearing
6.	119115	2	Shield Cone, 12-Rib
7.	119103	1	Outer Shield Tube
8.	119104	1	Inner Shield Tube
9.	112012	1	Decal, Inner Warning
10.	112005	1	Decal, Outer Warning
11.	104021	1	Inner Drive Sleeve
12.	104022	1	Outer Drive Sleeve
Not Shown	102067	2	Bearing, Driveline Shield
Not Shown	104015	1	Driveline, 1 ³ / ₈ ", 6-Spline, Shear Clutch (cut to 30" model length)
Not Shown	104016	1	Driveline, 1 ³ / ₈ ", 6-Spline, Shear Clutch (cut to 22" model length)